

# CLIO

ELECTRICAL & ACOUSTICAL TESTS

**CLIO** win

*electrical and acoustical measurement system*

**CLIOwin 7**

Audiomatica  
Florence - Italy

Copyright © 1991-2006 AUDIOMATICA.  
All rights reserved. All product names are  
trademark or registered trademark of Audiomatica.

The screenshot displays a complex interface with a grid of data points and a central diagram. The diagram shows a curved structure with various labeled sections (A, B, C, D, E, F, G, H, I, J, K, L, M, N, O, P, Q, R, S, T, U, V, W, X, Y, Z) and numerical values. A prominent black waveform is overlaid on the diagram. The data table on the right contains columns of numbers and letters, likely representing test results or system parameters.

QC Software extension

User's Manual



© Copyright 1991–2006 by AUDIOMATICA SRL

All Rights Reserved

Edition 7.03QC, January 2006

IBM is a registered trademark of International Business Machines Corporation.  
Windows is a registered trademark of Microsoft Corporation.

# CONTENTS

<b>18 QUALITY CONTROL</b> .....	<b>5</b>
18.1 INTRODUCTION .....	5
18.2 FEATURES OF CLIOWIN QC .....	5
18.2.1 THE OPERATOR'S POINT OF VIEW .....	6
18.2.2 THE ENGINEER'S POINT OF VIEW .....	7
18.2.3 THE COMPANY'S POINT OF VIEW .....	9
18.3 THE QC SOFTWARE OPERATION .....	10
18.4 THE QC CONTROL PANEL .....	14
18.4.1 TOOLBAR BUTTONS .....	14
18.4.2 THE QC REPORT PANEL .....	16
18.4.3 REVIEWING A MEASUREMENT .....	17
18.4.4 THE QC RESULT PANEL .....	19
18.4.5 THE QC BANNER .....	19
18.4.6 QUALITY CONTROL MENU AND SHORTCUTS .....	20
18.4.7 QC REGISTERED FILE EXTENSIONS .....	21
18.5 MY FIRST QC SCRIPT .....	22
18.5.1 WHAT TO KNOW ABOUT QC SCRIPTS .....	22
18.5.2 HOW TO WRITE MY FIRST QC SCRIPT .....	22
18.6 NOTES ON LIMITS CURVES .....	26
18.6.1 ABSOLUTE VS. RELATIVE FREQUENCY LIMITS .....	27
18.6.2 AVERAGE LEVEL CHECK .....	28
18.6.3 ALIGNED MASK .....	31
18.6.4 SENSITIVITY CHECK .....	32
18.6.5 FLOATING LIMITS VS. FLOATING CURVES .....	33
18.6.6 THIELE&SMALL PARAMETERS CHECK .....	34
18.6.7 SINUSOIDAL THD AND HARMONICS CHECK .....	35
18.6.8 MULTIMETER LIMITS FILES .....	37
18.7 MANAGING PRODUCTION BATCHES .....	38
18.7.1 DIRECTORIES CREATED BY CLIOWIN QC .....	38
18.7.2 PRODUCTION REPORT FILES .....	39
18.7.3 AUTOSAVED DATA FILES .....	40
18.7.4 WYSIWYG OPERATION .....	40
18.7.5 STATISTICAL INFORMATION ON MEASURED DATA .....	41
18.7.6 SERIAL NUMBER MANAGEMENT .....	42
18.7.6 THE SKIP LAST BUTTON .....	42
18.8 INTERACTING WITH EXTERNAL HARDWARE .....	43
18.8.1 INPUT SENSITIVITY AND OUTPUT VOLTAGE CONTROL .....	43
18.8.2 SC-01 DC OUTPUT CONTROL .....	43
18.8.3 CLIOQC AMPLIFIER&SWITCHBOX CONTROL .....	44
18.8.4 EXTERNAL TRIGGER .....	44
18.8.5 TTL SIGNALS GENERATION .....	45
18.8.6 TIME DELAYS GENERATION .....	46
18.8.7 PARALLEL PORT SIGNALS MANAGEMENT .....	47
18.8.6 RS-232 SERIAL PORT CONTROL .....	48
18.9 LEARNING CLIOWIN QC WITH EXAMPLES .....	49
18.9.1 EXAMPLE 1: QC OF A MICROPHONE PREAMPLIFIER .....	49
18.9.2 EXAMPLE 2: THE AMPLIFIER&SWITCHBOX UNDER QC .....	52
18.9.3 EXAMPLE 3: A FOUR-WAYS CROSSOVER .....	55
18.9.4 EXAMPLE 4: A MEDIUM SIZED PRODUCTION OF A 13CM DRIVER .....	57
18.9.5 EXAMPLE 5: A LARGE SIZED PRODUCTION OF A 2CM TELEPHONE SPEAKER ..	59

18.9.6 EXAMPLE 6: A CYCLIC SCRIPT (USED TO MANAGE MY ROGERS LS3/5A TWO-WAY LOUDSPEAKER PRODUCTION) .....	61
18.9.7 EXAMPLE 7: RUB & BUZZ DETECTION (1) .....	64
18.9.8 EXAMPLE 8: RUB & BUZZ DETECTION (2) .....	66
18.9.9 EXAMPLE 9: RUB & BUZZ DETECTION (3) .....	66
18.10 QC SCRIPT SYNTAX REFERENCE .....	69
18.10.1 KEYWORDS FOR GENERAL SETTINGS .....	69
18.10.2 KEYWORDS FOR MEASUREMENTS SETTINGS .....	73
18.10.3 KEYWORDS FOR MATH OPERATION .....	76
18.10.4 KEYWORDS FOR CONDITIONAL EXECUTION .....	77
18.10.4 KEYWORDS FOR HARDWARE CONTROL .....	80
18.10.5 OTHER KEYWORDS .....	81
18.10.6 KEYWORDS USED IN LIMITS FILES .....	82

**BIBLIOGRAPHY ..... 87**

**NORMS ..... 89**

# 18 QUALITY CONTROL

## 18.1 INTRODUCTION

The Quality Control software extension for CLIOwin is a powerful suite for executing state of the art production line testing.

CLIOwin QC implements all the measurement techniques found in the CLIOwin standard software adding a versatile script processor that handles the test sequence most appropriate for your needs.

CLIOwin QC is able to test the production of loudspeakers, drivers, microphones, amplifiers and any other electroacoustic device.

CLIOwin QC can interact with external hardware or production line controllers in addition to PC peripherals, computer networks or with custom written software to implement a fully automatic test line.

## 18.2 FEATURES OF CLIOWIN QC

CLIOwin QC is exceptionally powerful as it relies on the power of CLIOwin.

Some of the measurements possible:

- Frequency response with MLS, LogChirp or Sinusoidal Sweep
- Impedance with MLS, LogChirp or Sinusoids
- Rub & Buzz for loudspeakers
- Polarity
- Single harmonic or THD response with Sinusoidal Sweep
- Narrowband FFT analysis with definable stimulus
- T&S parameters
- Sensitivity
- Frequency
- THD
- IMD
- Noise

The application of single measurements or the combination of more provides the best answer to complex topics like **rub & buzz testing**.

Some of the QC management features are better explained starting from the various people taking part in this complex operation and their points of view:

- The operator working on the line
- The quality control engineer responsible for production line operation
- The company and its managers controlling the overall process

## 18.2.1 THE OPERATOR'S POINT OF VIEW

A quality control test can be controlled by simple Go-NoGo masks letting even the least experienced operator work without problems and with no learning curve.



Figure 18.1

A more complex operation foresees the continuous display of the measurements executed until the reaching of the final result.

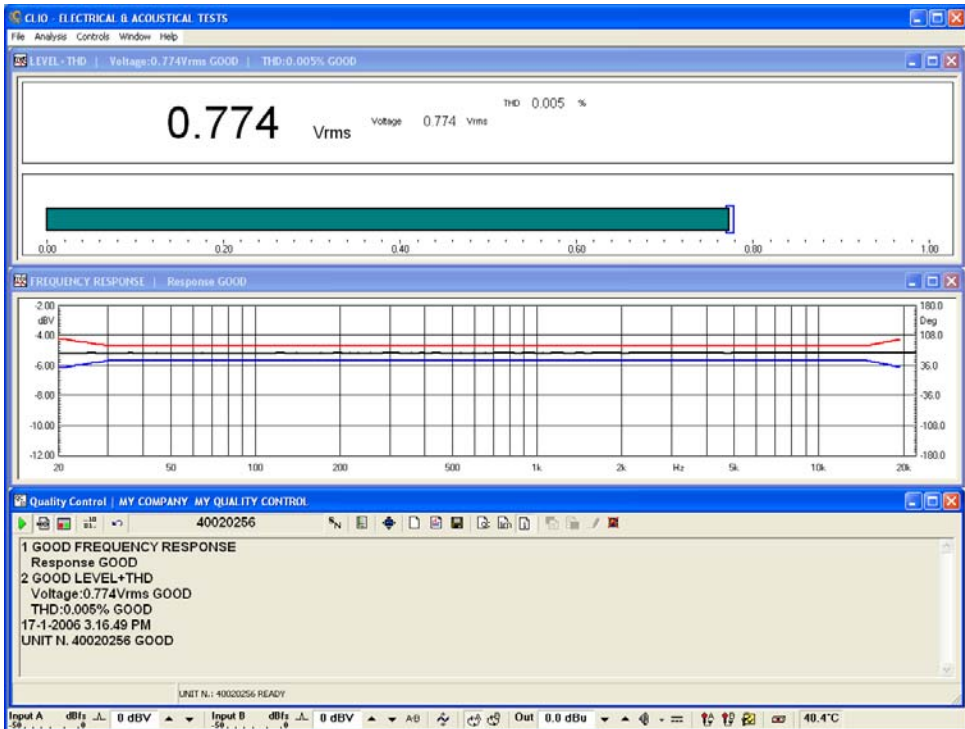

Figure 18.2

A third possibility is to view and interact with the test sequence during its execution.

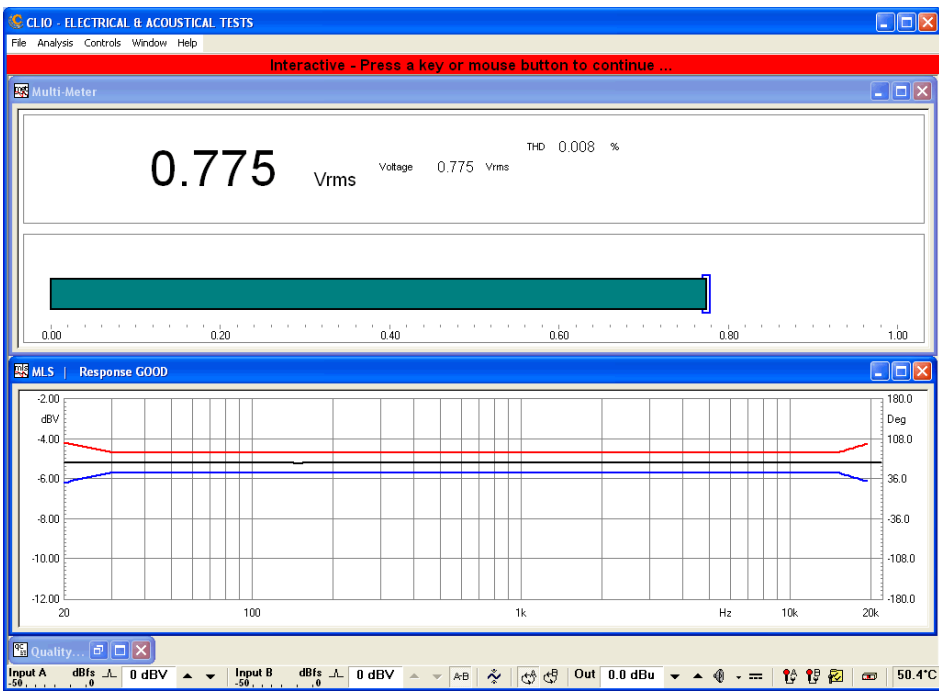

Figure 18.3

Completed test information and reports are always presented to the user.

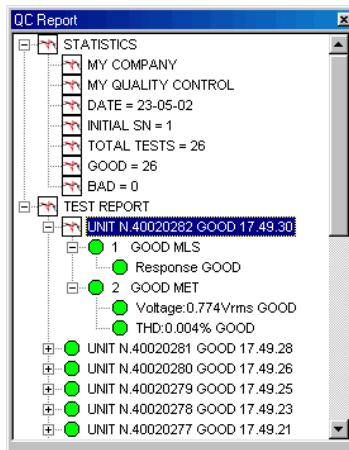

Figure 18.4

### 18.2.2 THE ENGINEER'S POINT OF VIEW

As the QC is integrated inside the CLIOwin software no new user interface has to be learned by the engineer who has experience of CLIOwin inside her or his research laboratory. A quality control test relies on real measurements saved on disk and on a simple text script.

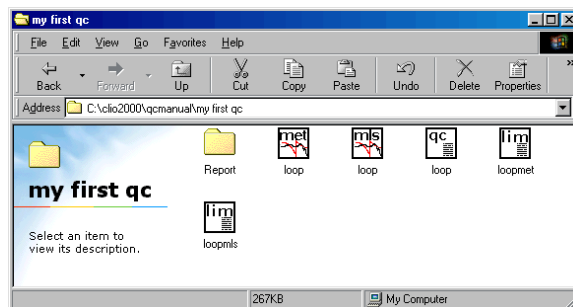

Figure 18.5

Defining a QC script is easy as it requires the writing only a few descriptive lines of text, no programming languages or complex instructions are involved.

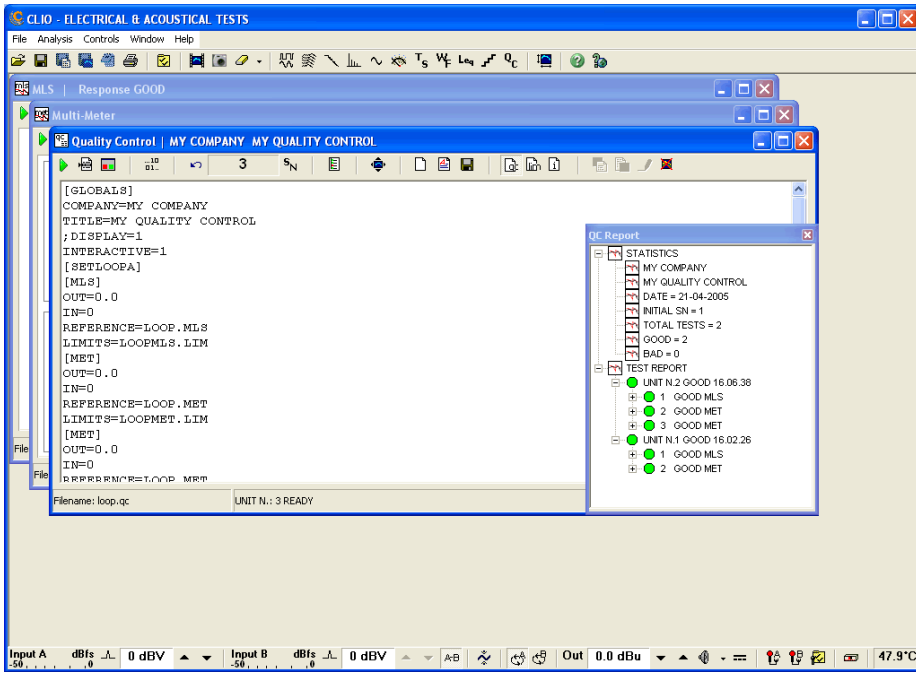

Figure 18.6

It is possible to capture the active measurement; the check masks can also be input in a visual manner drawing limits over the measurement; debugging is helped by an internal corrector.

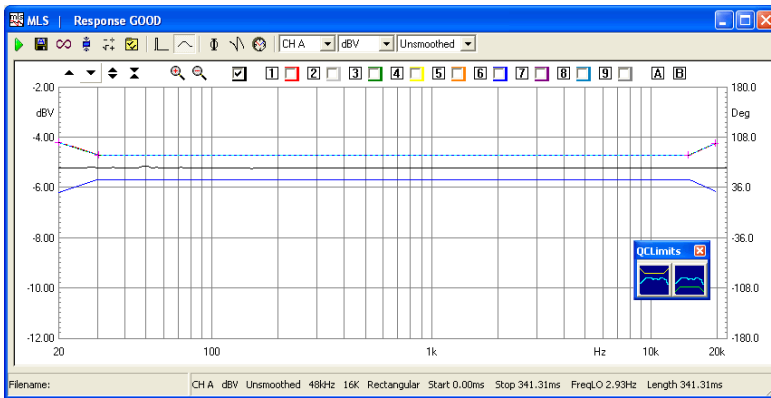

Figure 18.7

### 18.2.3 THE COMPANY'S POINT OF VIEW

CLIOwin when used for quality control executes line testing in a fast, accurate and reliable manner. Its flexibility permits easy handling of trade-offs between parameters like speed and accuracy always matching the companys' needs. The autosaving and exporting capabilities together the complete result reporting gives instant access to the production parameters and statistics even during its operation. The production batch is fully managed while preserving serial number coherence.

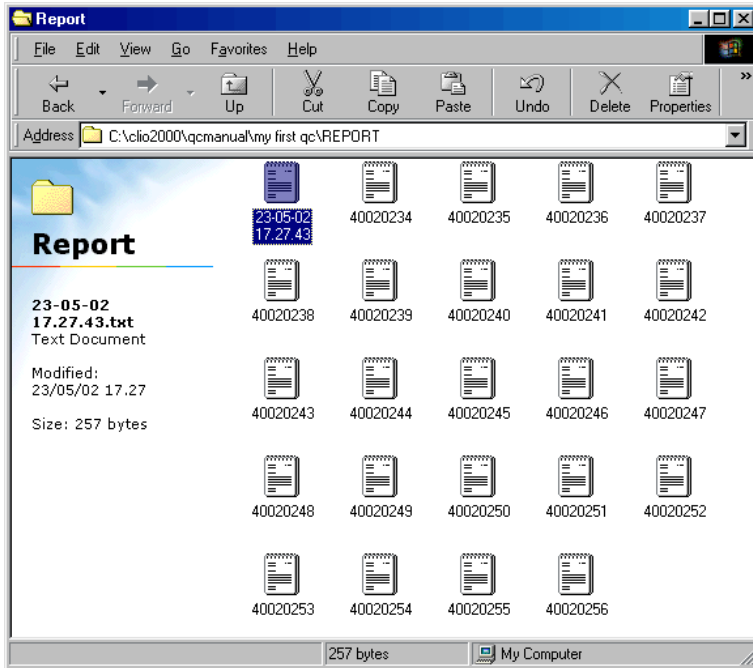

Figure 18.8

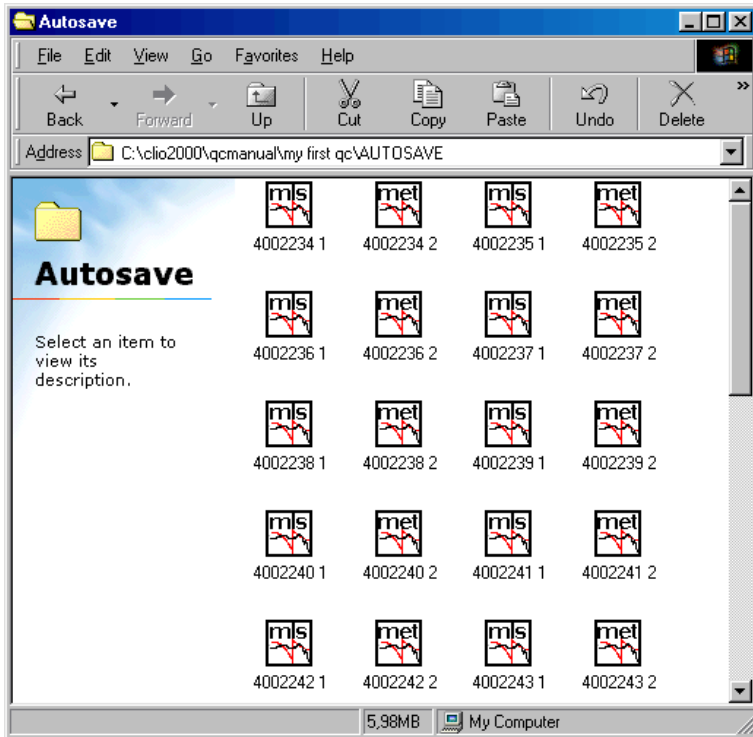

Figure 18.9

## 18.3 THE QC SOFTWARE OPERATION

The QC software is a "file driven" event processor that, in sequence, performs a number of user-defined measurements to test the quality of a production line. The text file ('.qc' extension) driving this process is called the **QC Script**.

CLIO's QC processor does the following job:

- reads the QC script and loads it in memory
- interprets it
- executes all the tests
- reports the test result and production statistics
- manages the production batch and serial number
- prompts for the next test

The following block diagram outlines the QC process.

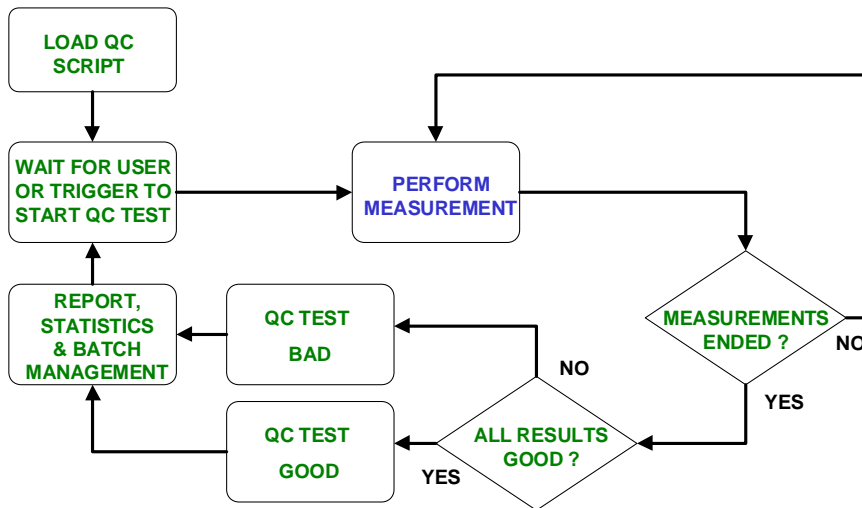

Figure 18.10

You can see the operation of loading the QC script from disk that begins our quality control session; then CLIO waits for that the user, or an external trigger (for example a TTL signal from the automation controller), to give the actual start to the QC test; the measurements defined are then executed in sequence until the last is reached; the result of the test is given by the sum of all the checks done inside the test sequence, it is only good if all checks gave a positive result; the QC test ends by updating the report and statistics while managing the production batch; the next device can then be put under test.

To proceed further it is advisable to go into the former block diagram in greater detail; this is done in Fig. 18.11 and 18.12; Fig. 18.11 zooms the entire QC test sequence adding the blocks in red, while Fig. 18.12 zooms the "Perform Measurement " single block (the blue one).

Three different operating modes are outlined here: the DISPLAY mode, the INTERACTIVE mode and the DISPLAYONBAD mode.

**If none of these modes are active the QC test proceeds without any measurements shown, with simple go-no-go masks, as in Fig. 18.1.**

If **DISPLAY** mode is active then the executed measurements are shown and remain on the screen for a definable amount of time, the test automatically proceeds until the end. Fig. 18.2 depicts such a situation.

If **INTERACTIVE** mode is active the executed measurements are shown and then the software prompts for user input . The test sequence is not continued until the user executes a particular action or actions. It is also possible to loop certain measurements for D.U.T. tuning (see Fig.18.12). Fig.18.3 depicts such a situation.

If **DISPLAYONBAD** mode is active then the executed measurements are shown only if their result is not satisfactory. The sequence is stopped for user acceptance.

Fig.18.11 shows also the **Autosave** management which is of great importance for controlling the production and for characterizing a batch. This feature is completely user definable allowing for binary or text files, operation conditioned by the test result, coherence with serial number and single test number; the operator can also be prompted for file name input.

Two blocks are devoted to the execution of particular actions conditioned by the result of the single test or the result of all tests. Among these we find:

- messages to the operator
- printout of the measurement
- execution of custom written software
- generation of TTL signals to manage automatic lines
- pause for a predefined amount of time
- stop the sequence

The last red block, right before the end of the QC test, represents the **Cyclic Script**. The cyclic script is a particular sequence of QC operations described and saved in a script file that is executed regularly after a certain number of QC tests have been executed; this is useful for retesting reference quantities that characterize the entire process and maintain traceability to environmental conditions. The typical example is the reference loudspeaker tested every 100 production units have passes the QC test.

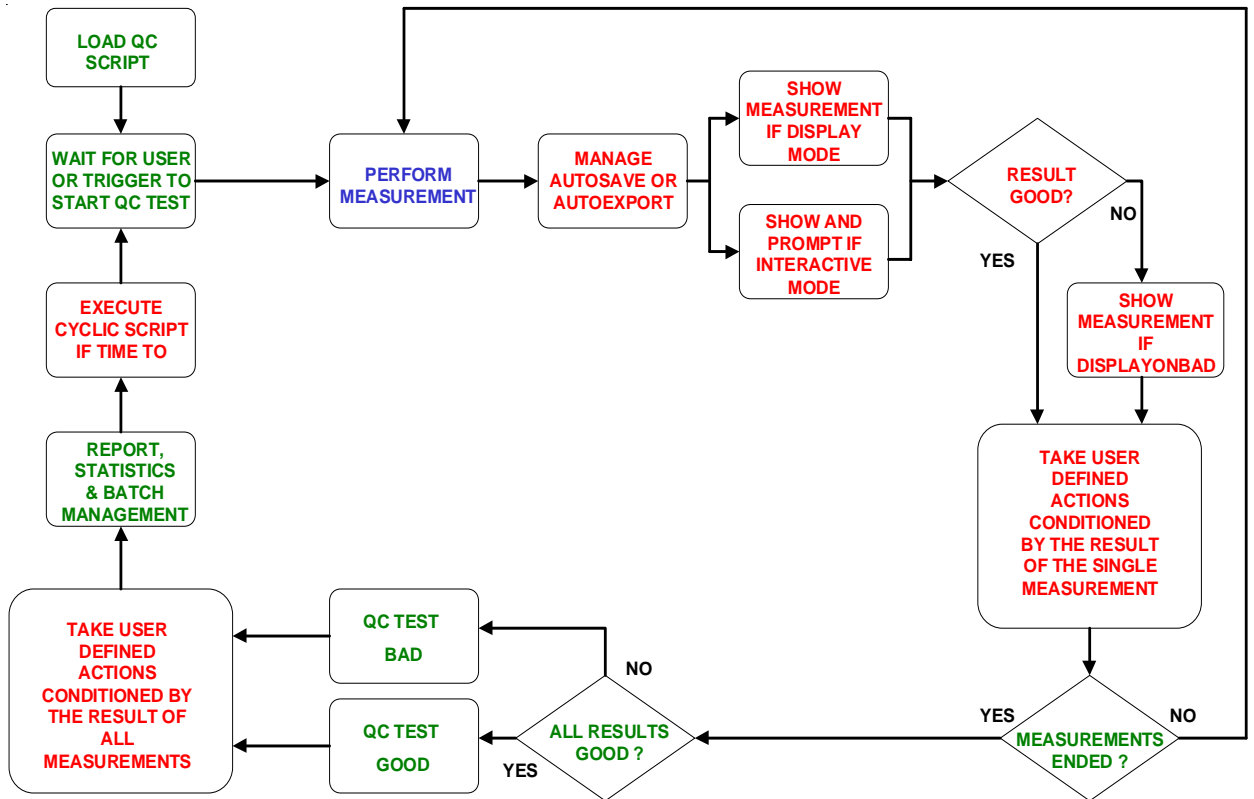

Figure 18.11

The third diagram in Fig. 18.12 shows us how the single QC measurement is performed. As intimated before, CLIOwin QC relies on the measurements present in the standard version of the software; the possible measurements within QC are: MLS ([**MLS**]), FFT ([**FFT**]), Sinusoidal ([**SIN**]) and Multimeter ([**MET**]). We will now cover the keywords which are used to define the tests inside the script.

To understand this operation we must define two files: the **Reference File** and the **Limits File**; these files are the heart of the QC operation, together the QC Script they contribute to define all the parameters of the single measurement.

The Reference File is a standard CLIOwin measurement file (extension '.mls', '.mlsi', '.fft', '.sin', '.sini' or '.met') created within its relative menu; it contains most of the settings needed to fully configure your measurement. Just as CLIOwin resets the measurement control panel to the settings of the file loaded from disk, the QC processor does the same job; in this easy but effective way of operating you will be sure that, for example, the sampling frequency of your QC MLS measure will be the one you chose, or the display settings will be the same as when you saved the reference file. And all this is defined, inside the QC script, with a **single** text line:

```
REFERENCE=myreferencefile.mls
```

where we imagined that you gave the name 'myreferencefile' to a saved MLS measurement.

The Limits File is a text file ('.lim' extension) defining the frequency mask or quantities needed to check the executed measurement. The syntax used is the same as the QC script. A Limits file can be as simple as:

```
[UPPER LIMIT DATA]
100                +5
500                +3
5000               +1
10000              +5
[LOWER LIMIT DATA]
100                -5
500                -3
5000               -1
10000              -5
```

In principle nothing else is needed to define the basic measurement; here is an example of a section of a QC script defining a MLS measurement:

```
[MLS]
REFERENCE=MYREFERENCEFILE.MLS
LIMITS=MYLIMITSFILE.LIM
```

An interesting keyword to add is COMMENT that let's you give a brief description of the QC test that will be output during the measurement and inside reports:

```
[MLS]
COMMENT=FREQUENCY RESPONSE
REFERENCE=MYREFERENCEFILE.MLS
LIMITS=MYLIMITSFILE.LIM
```

While performing a QC measurement CLIO can calculate more parameters from the data acquired and have these parameters to concur with the final result. As an example

it is possible to make a polarity check within a MLS frequency response measurement or make a T&S parameters check within an impedance measurement. The following script adds the polarity check to the former MLS test.

```
[MLS]
REFERENCE=MYREFERENCEFILE.MLS
LIMITS=MYLIMITSFILE.LIM
POLARITY=1
```

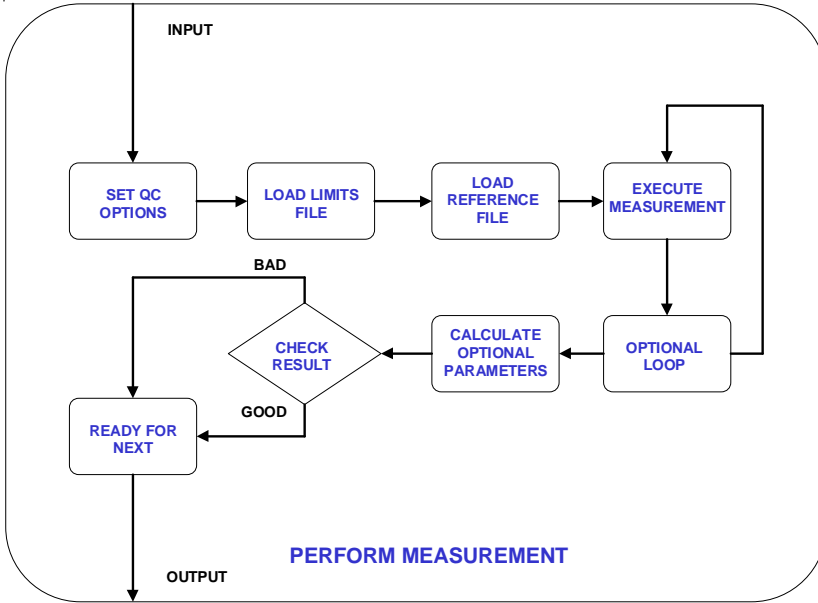

Figure 18.12

Here is a list of the parameters that can be calculated within each measurement:

- MLS
  - Average (or single frequency) level
  - Sensitivity (average or up to eight frequencies)
  - Polarity
  - T&S parameters (Fs,Qt,Qe,Qm,Cms,Mms,Mmd,Vas,BI,dBSPL,ZMin)
- FFT
  - Average (or single frequency) level
  - Sensitivity (average or up to eight frequencies)
- Sinusoidal
  - Average (or single frequency) level
  - Sensitivity (average or up to eight frequencies)
  - 2nd harmonic response
  - 3rd harmonic response
  - 4th harmonic response
  - 5th harmonic response
  - Total harmonic distortion response
  - T&S parameters (Fs,Qt,Qe,Qm,Cms,Mms,Mmd,Vas,BI,dBSPL,ZMin)

## 18.4 THE QC CONTROL PANEL

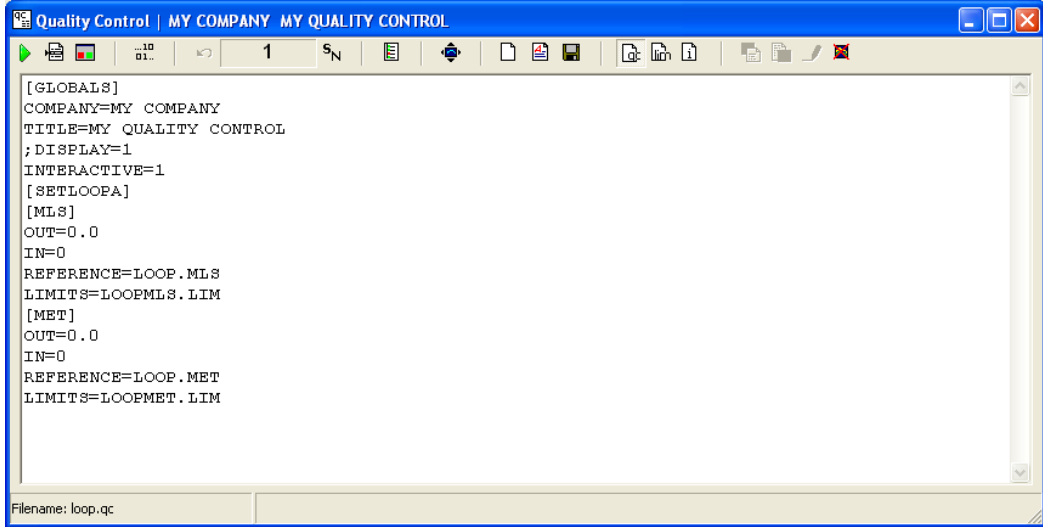

Figure 18.13

Figure 18.13 shows the Quality Control panel that is composed by a toolbar similar to the other CLIOwin panels plus a text display area that is used either for editing the QC files (QC script and Limits file) or for showing information about the QC test.

When the QC display handles file editing it has a white background while, when showing information, it is lightly colored.

### 18.4.1 TOOLBAR BUTTONS



Starts a QC test.



Enables tracing of the QC script during execution. If pressed, during test execution the QC control panel is not minimized and remains visible showing the current script section under execution.



Forces the QC result panel to be displayed after tests completion. Refer to 18.4.3 for more details.



#### shrink QC result drop down

With this choice in the drop down menu associated with the QC result button it is possible to display a minimized version of the QC Result Panel; see 18.4.4.



Enables external trigger. This button overrides the setting in the script (**MANUAL** keyword). See 18.8.2 and the commands reference for more details.



Skips the last measured unit.



Used to input the current device serial number.



Recalls the QC Report panel Refer to 18.4.2 for more details.

Releases all the measurement control panels. Each panel reverts to its normal appearance. In fact, when a QC test sequence is running, each panel 'loses' its toolbar, overlay and curve controls and status bar in order to maximize the graph display when the windows are tiled. Fig.18.14 shows the MLS control panel in the two different situations.

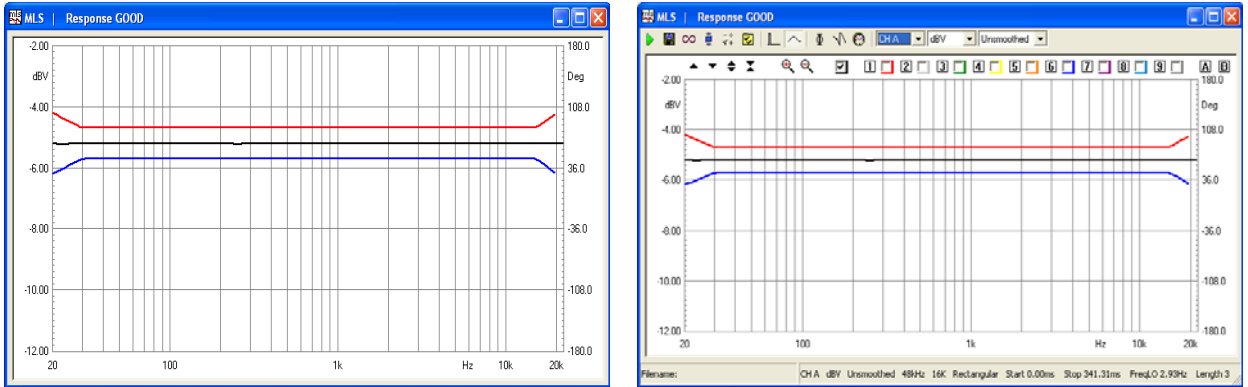









Figure 18.14

When control panels are managed under QC the title of the window is used to display the result of the parameters that have been measured or calculated: in Fig.18.15 we see written 'Response GOOD' which reports the result of the MLS frequency response check done.

-  Starts a new QC script editing session. The text present is cancelled.
-  Edit the current text.
-  Immediately saves the current text as Script or Limits file.
-  Enters the **Script Text mode**. The QC display presents the currently loaded QC script file.
-  Enters the **Limits Text mode**. The QC display presents the currently loaded Limits file.
-  Enters the **Information Text mode**. During tests the QC display shows the current QC script section under execution. When the test sequence is finished the QC display shows information about the executed tests.
-  If in **Script Text display mode**, 'captures' the active measurement generating a 'piece' of script file relative to the currently loaded reference and limits files. The text is inserted at cursor position. As an example the following text is generated in the assumption that you have MLS open with the active measurement saved as 'myreferencefile.mls' and that you have loaded the 'mylimitsfile.lim' inside QC; also captured are output level and input sensitivity (here assumed to be 0dBu and 0dBV respectively).

```
[MLS]
OUT=0.0
IN=0
REFERENCE=MYREFERENCEFILE.MLS
LIMITS=MYLIMITSFILE.LIM
```

If in **Limits Text display mode**, 'captures' the limits file of the active measurement loading it inside the QC display.

 Creates the frequency curves relative to the limits file under editing and shows them in the active measurement control panel.

 Enables the Draw Limits controls that let you visually input the frequency limits directly drawing on the active measurement control panel. Fig. 18.15 shows the MLS control panel with the Draw Limits controls on the top. Clicking on one of the two buttons starts drawing the relative limit curve; to finish input **double-click** on the last frequency point.

Note: it is mandatory to input points from left to right.

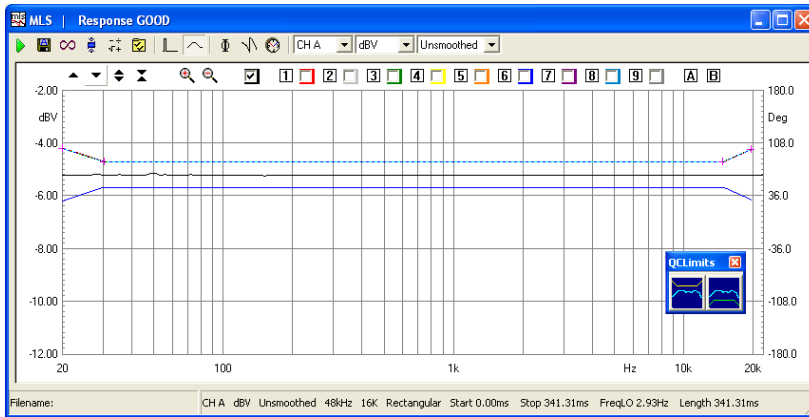



Figure 18.15

 Hides (if visible) or shows (if hidden) the limits curves in the active measurement control panel.

## 18.4.2 THE QC REPORT PANEL

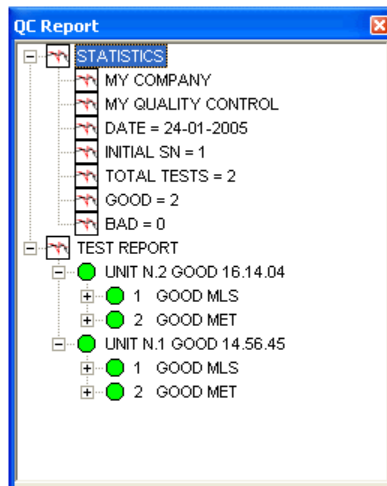

Figure 18.16

The QC Report panel serves as an interactive tool which is of great help for inspecting a production while it is tested; it is composed by two tree views named **STATISTICS** and **TEST REPORT** these handle all the information pertaining to your QC session in a very compact form.

The QC Report panel can be kept open during the tests and it accompanies the work in a really effective visual form.

Under STATISTICS you find information about:

- QC test and Company names
- Date of the first unit tested
- Name of the production batch
- First serial number tested
- Total number of units tested, number of "good" and "bad" units

Under TEST REPORT you find information about:

- DUT test result with serial number and time of production
- Single tests results
- Names of the saved files

The QC Report panel is also the starting point for reviewing a saved measurement as described below. The name of the saved file is a sensible area where you can double-click to review the measurement.

### 18.4.3 REVIEWING A MEASUREMENT

During a QC tests session it is possible to review a measurement that has been saved to disk. This is important when, for example, trying to understand why a measurement went bad. As we saw before the QC report panel indicates all the names of the files that have been created during the test execution, under the relative serial number and single test number.

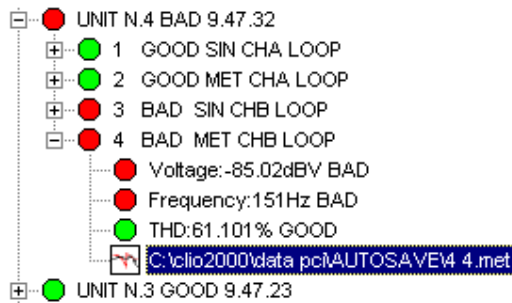

Figure 18.17

As soon as a QC sequence is terminated simply open the tree view of your interest, identify the measurement you want to inspect and double click on its name (Fig.18.17). CLIO loads the measurement as if it were performed inside the running QC, together with its pertinent limits and executes all the calculations defined in the QC script ending with the result check and display. Fig.18.18 describes such a process; compare it with Fig.18.12.

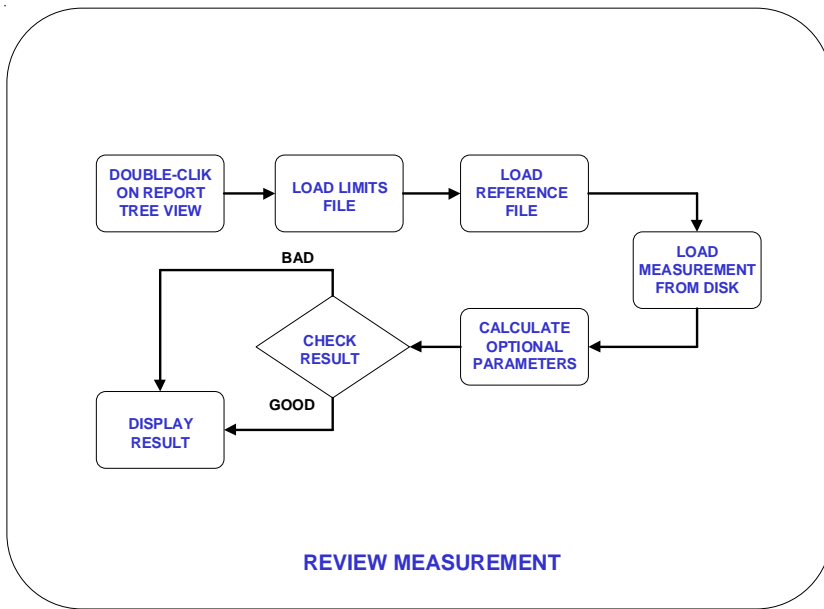

Figure 18.18

Reviewing a saved measurement from within QC is different from simply opening the file from the measurement control panel; in this second case no post processing due to QC operation is applied. Fig. 18.19 shows a measurement (black curve) reviewed inside QC with its limits (red and blue curves) and the same measurement loaded from the measurement control panel (purple curve); the shift in level is due to QC operation when it separately checks for relative level and frequency behavior.

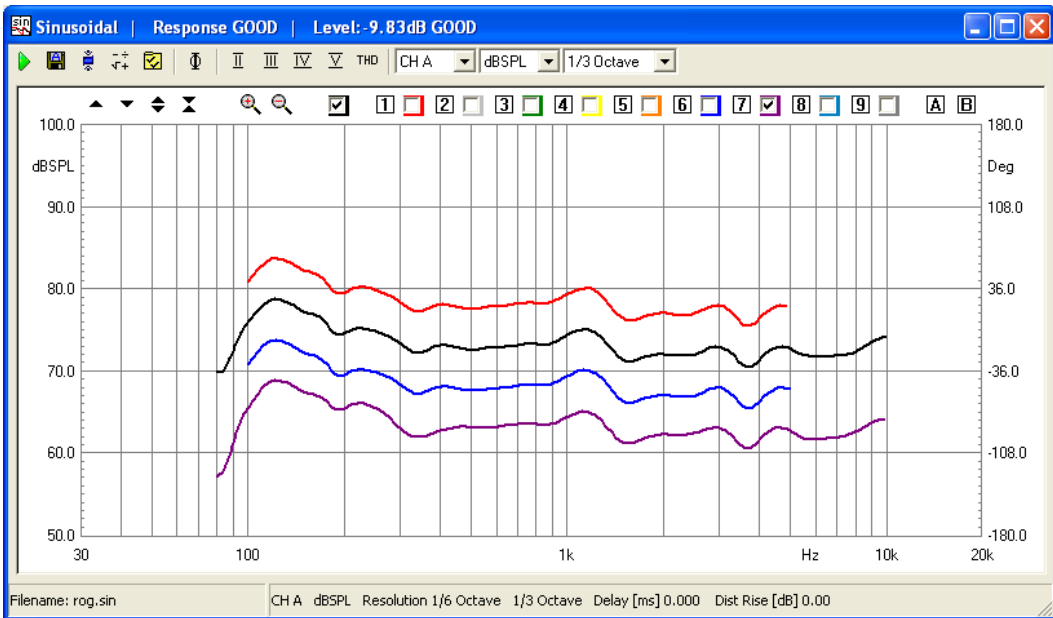

Figure 18.19

Note: the review operation can be done only when inside a QC session; if CLIOwin is exited, then later QC is started again a new QC session will be created; report information and review operation will only apply to the new session.

### 18.4.4 THE QC RESULT PANEL



Figure 18.20

The QC Result panel usually accompanies QC sessions where measurement display is not needed. This results in a situation with simple go-no-go masks for use with completely automatic lines or for operators who don't need to take particular actions with respect to the test result.

To activated the QC Result panel from within the QC script use the DISPLAY=0 keyword.

**Note: for maximum QC test speed use the QC Result display and don't show single measurements as the display of graphical objects and measurement curves usually employs a lot of processor time.**

The QC Result panel can be forced to appear at the end of the QC sequence pressing the  button.

If Shrink QC result is selected in the associated drop down menu the QC result panel will appear in a minimized version.

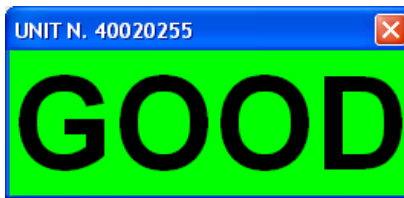

### 18.4.5 THE QC BANNER

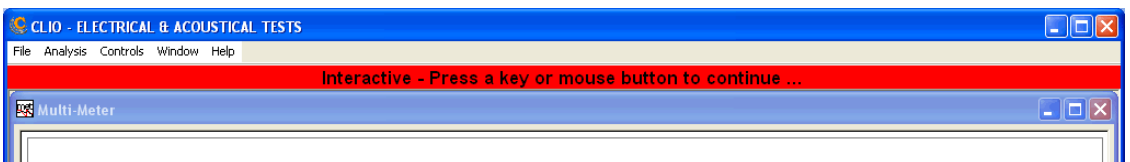

Figure 18.21

The QC Banner is managing information and messages given to the operator while in Interactive mode.

## 18.4.6 QUALITY CONTROL MENU AND SHORTCUTS

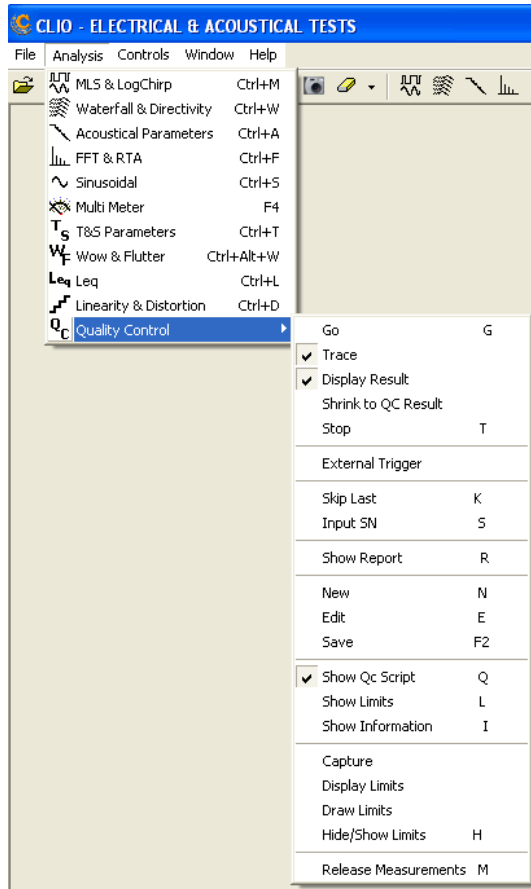

Figure 18.22

Figure 18.22 shows the Quality Control menu accessible from the Analysis menu. Seen below is a list of all the available Hot Keys.

### ESC or T

Exits the QC test sequence.

### End

Exits the QC test sequence in Interactive mode.

### SpaceBar

Continues the QC test sequence in Interactive mode.

**G** Starts a QC test. Equivalent to .

**K** Skip last executed measurement. Equivalent to .

**S** Input serial number. Equivalent to .

**R** Show Report. Equivalent to .

**N** New QC script. Equivalent to .

**E** Edit QC script. Equivalent to .

**F2** Saves QC script. Equivalent to 

**CTRL-E**

Ends an editing session, while inside the text display.

**CTRL-C**

Copy selected text.

**CTRL-V**

Paste selected text.

**CTRL-X**

Cut selected text.

**CTRL-Z**

Undo/redo text input.

**Q** Show QC script. Equivalent to 

**L** Show Limits. Equivalent to 

**I** Show Information. Equivalent to 

**H** Hide Limits. Equivalent to 

**M** Release measurements. Equivalent to 

### 18.4.7 QC REGISTERED FILE EXTENSIONS

CLIOwin Quality Control registers the following files extensions beyond the ones already registered by CLIOwin.



QC script files.



QC Limits files.

## 18.5 MY FIRST QC SCRIPT

### 18.5.1 WHAT TO KNOW ABOUT QC SCRIPTS

A quality control script is a text file that stores information in logical groupings, called **sections**.

Each section is initiated by a bracketed keyword in the form **[keyword]**.

Within each section, QC definitions are stored in named keys.

Keys within a section take the form **keyword=value**.

For example the section called [GLOBALS] defines several settings useful all along the test sequence:

```
[GLOBALS]
COMPANY=MY COMPANY
TITLE=MY QUALITY CONTROL
BATCH=MY PRODUCTION BATCH NAME
```

It is possible to input comment lines initiated by a **semicolon**. It is **not** possible to start a comment after a keyword.

```
;this is a correct comment line
COMPANY=MY COMPANY ;this comment is not allowed
```

With an understanding of these brief notes you are ready to write a QC script.

### 18.5.2 HOW TO WRITE MY FIRST QC SCRIPT

You may write your script with any text editor that stores plain ASCII files (usually '.txt' ones), like Notepad; the only thing you should remember is that QC scripts must have the '.qc' extension while limits files use the '.lim' extension; the common behavior of Windows to hide registered file extensions sometimes renders this action difficult. It is not uncommon to believe you have saved a file with, say, the name 'myfile.qc' (where you tried to force the extension) and then find it actually saved as 'myfile.qc.txt' because the text editor automatically appended the registered extension.

You may write your script directly by editing it within the QC control panel text display; in this case the extension management is guaranteed by CLIOwin and you will be able to use some tools, like measurements capture, that are of help during everyday jobs. By doing it like this it is possible to immediately test the script by pressing Go.

**Let's now write our first QC script.**

Have your CLIO system in the same setup as when you performed the system calibration: output A connected to input A; see chapter 3 for details. Don't connect any external device to the system. Set output level at 0dBu and input sensitivity at 0dBV (see Chapter 4 for details). Have the default settings loaded.

Open MLS; press Go. You should obtain a straight line as in Fig. 18.23. Expand the display to obtain 2dB/div and set upper Y scale value to -2dBV. Save this measurement as 'Loop.mls'.

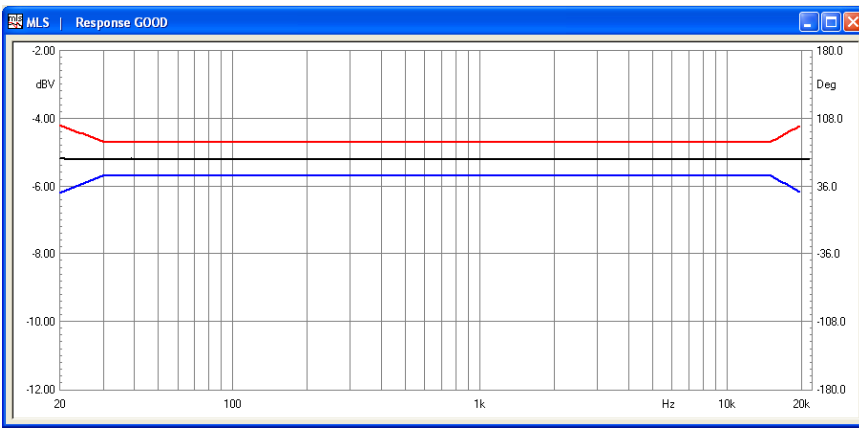





Figure 18.23

Now open the QC control panel. Press **N**, we are starting a new script. Press **Ctrl-E** to exit edit mode and then press **L** to enter Limits Text mode. Input the following frequency masks as limits:

```
[UPPER LIMIT DATA]
20          -4.2
30          -4.7
15000      -4.7
20000      -4.2
[LOWER LIMIT DATA]
20          -6.2
30          -5.7
15000      -5.7
20000      -6.2
```

Press **F2** and save the limits file as 'loopmls.lim'. Now click now on the  (script) button and then click on the  (capture) button. Your blank text display should now be filled with your first QC script:

```
[MLS]
OUT=0.0
IN=0
REFERENCE=LOOP.MLS
LIMITS=LOOPMLS.LIM
COMMENT=FREQUENCY RESPONSE
```

Click on the  go button; the QC processor should execute a QC test performing an MLS measurement, displaying it together with the defined limits, everything as in Fig.18.24; the text display should now present information on the executed test.

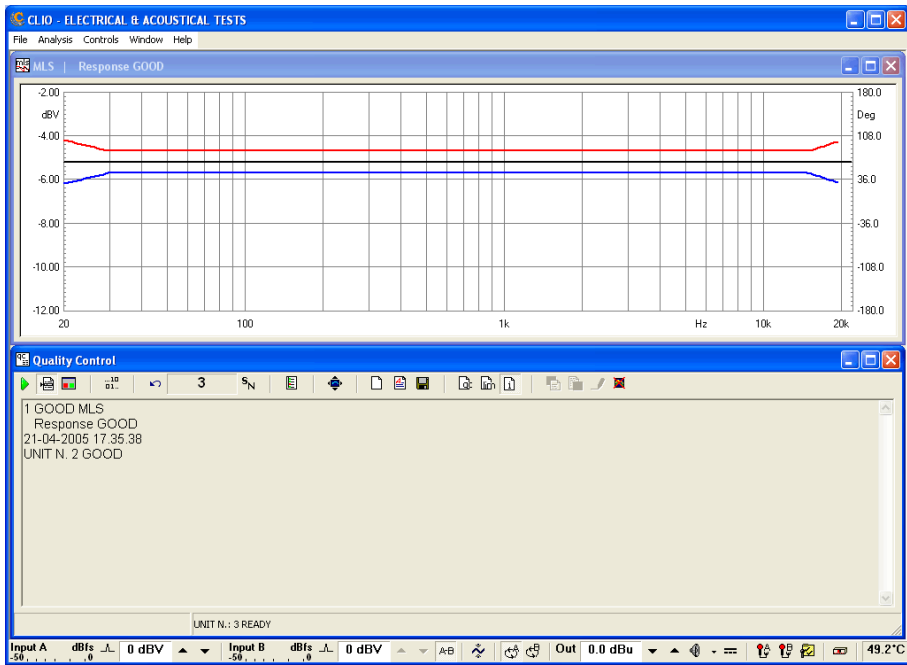



Figure 18.24

Let's now complete this first exercise by adding a Multimeter measurement of level and total harmonic distortion at 1kHz.

Press **F4** to open (and run) the Multimeter control panel, then click on the  generator button to switch the generator on and play the default 1kHz sinusoid. Now press **T** to stop measuring; save this measurement as 'loop.met'; Fig.18.25 should be what you have in front of you.

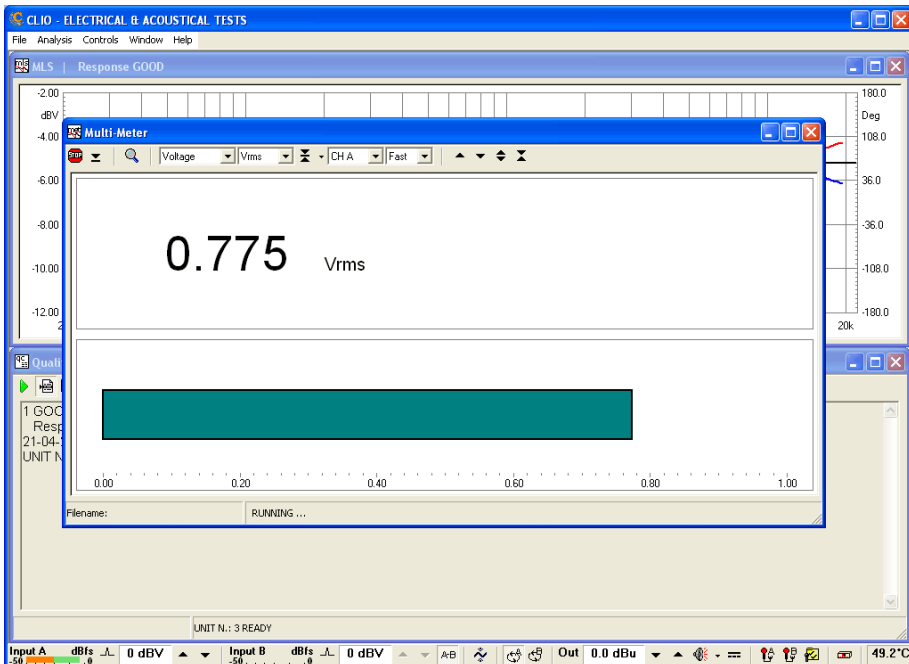



Figure 18.25

Now press **Ctrl-Q** and then **L** to go back to inputting a limits file definition. Input the following:

```
[UPPER LIMIT DATA]
VOLTAGE=0.78
THD=0.01
```

```
[LOWER LIMIT DATA]
VOLTAGE=0.77
THD=0.0001
```

Save this as 'loopmet.lim'. Now click on the  button and position the cursor inside the text display after the last line of text; as before, click on the capture button and the following lines should be added and you are ready for this new QC test.

```
[MET]
OUT=0.0
IN=0
REFERENCE=LOOP.MET
LIMITS=LOOPMET.LIM
COMMENT=LEVEL+THD
```

Now pressing the Go inside QC executes this two-measurement QC test sequence; Fig.18.26 shows the test at its end.

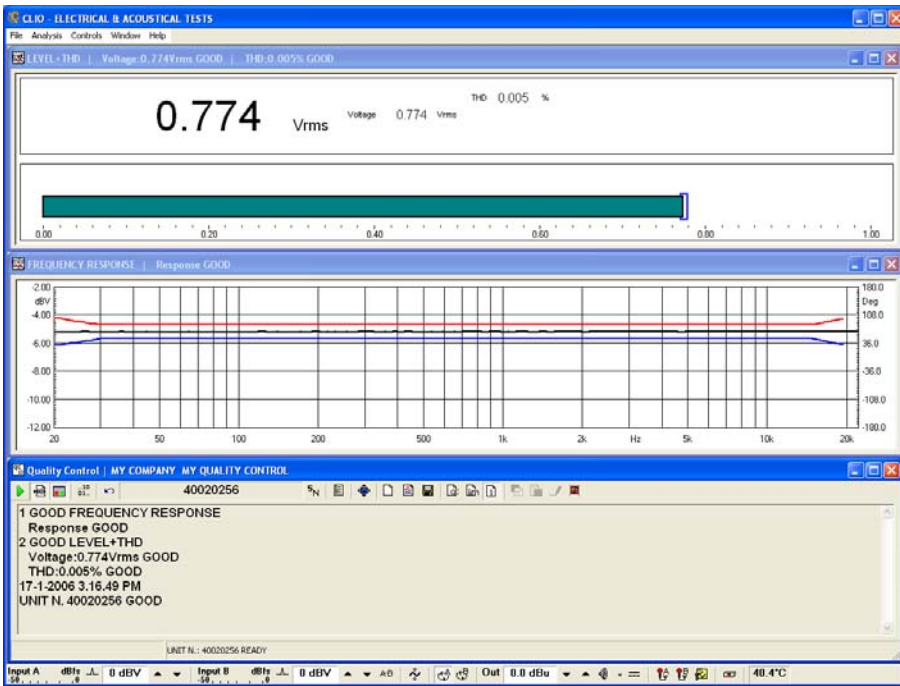

Figure 18.26

This concludes our first approach to QC script writing and debugging. All the files necessary to "study this lesson" are furnished within the '\DATA\MY FIRST QC' directory under the CLIOwin installation directory.

The 'loop.qc' script is doing exactly what has just been described with a difference: measurements are performed in **interactive mode**; just load it and run it to feel the differences.

## 18.6 NOTES ON LIMITS CURVES

As previously outlined the QC processor needs limits data in order to perform the required checks. This data is saved within the limits files and usually represent a frequency mask (for frequency response and impedance tests) but they can also define a single value check (like, for example, a Qms test).

When dealing with frequency checks the options defined affect the way the frequency masks are calculated, the way data is displayed on screen and the way that the result is checked. It is also possible to add an average or single frequency level check that concurs with the final result.

Fig. 18.27 shows us the procedure for calculating the frequency mask after the limits file is loaded into memory. You can see that the frequency data sets saved under [UPPER LIMIT DATA] and [LOWER LIMIT DATA] are treated differently if the limits are absolute or relative (see 18.6.1) or if an aligned point is defined (see 18.6.3).

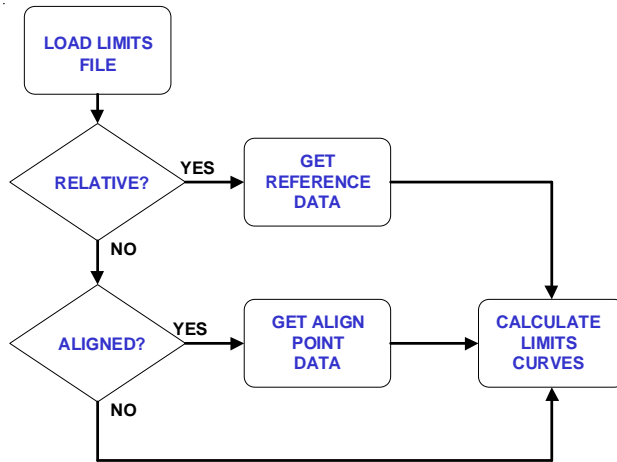

Figure 18.27

Fig.18.28 shows us the way a frequency check is performed and the measurement is presented on screen. You may appreciate the presence of an average level (or sensitivity) check (see 18.6.2) or a single point (aligned) level check (see 18.6.3) that concurs with the final result. **When a level (or sensitivity) check is defined, either the measured curve or the limits curves are shifted if presented on screen;** in this way it is possible to appreciate the frequency behaviour of the measured curve without the effect of a difference in sensitivity which is checked separately.

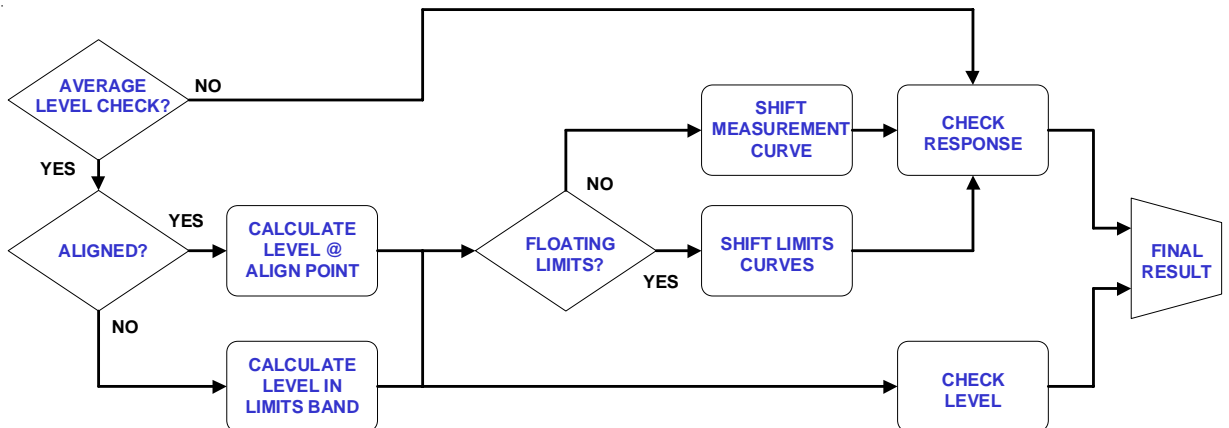

Figure 18.28a frequency plus average level check

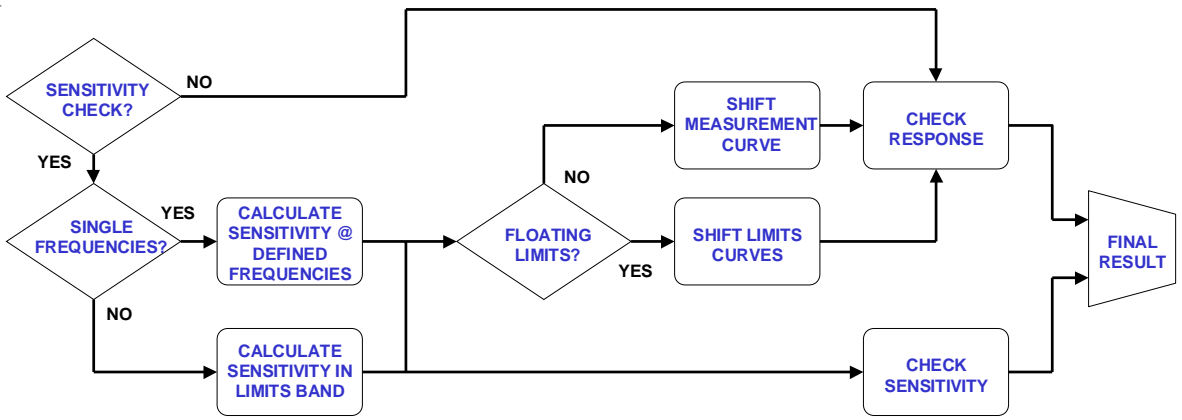

Figure 18.28b frequency plus sensitivity check

As a final, but not less important note, we now show how to define a limits file; it is possible to input the frequency mask as a text file as below.

```
[UPPER LIMIT DATA]
FILE=UPPER.TXT
[LOWER LIMIT DATA]
FILE=LOWER.TXT
```

The files 'upper.txt' and 'lower.txt' are export ASCII files that may be produced by other applications or CLIOwin itself.

The 'upper.txt' file may look like:

Freq[Hz]	dBV
100	5
500	3
5000	1
10000	5

### 18.6.1 ABSOLUTE VS. RELATIVE FREQUENCY LIMITS

The following limits file defines an **absolute** frequency limit.

```
[ABSOLUTE]
[UPPER LIMIT DATA]
200          100
300          97
10000       97
15000       100
[LOWER LIMIT DATA]
200          82
300          85
10000       85
15000       82
```

The frequency mask is shown in Fig.18.29.

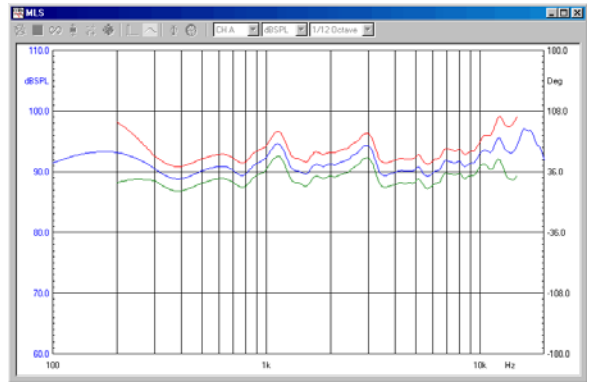
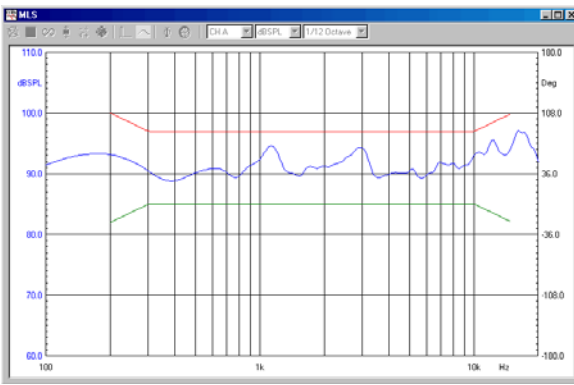

Figure 18.29 and 18.30

The following limits file defines a **relative** frequency limit.

```
[RELATIVE]
[UPPER LIMIT DATA]
200          5
300          2
10000       2
15000       5
[LOWER LIMIT DATA]
200         -5
300         -2
10000      -2
15000      -5
```

The frequency mask is shown in Fig.18.30. **Relative means with respect to the reference file defined in the QC test.** Data values will be added and subtracted to the reference value at the specified frequencies.

It is possible to input up to 100 frequency points to define the check mask. The QC processor will execute the check starting from the first frequency point, ending at the last; no check will be done outside this frequency range.

Inside a frequency limits file it is possible also to define an average level check (see 18.6.2 and 18.6.3), a sensitivity check (see 18.6.4) or a Thiele & Small parameters check (see 18.6.5).

A frequency limit file can be applied to an MLS, Sinusoidal or FFT test. To define a limits file for a Multimeter measurement see later.

### 18.6.2 AVERAGE LEVEL CHECK

The following limits file defines an **average level check** inside the same relative frequency limit shown before.

```
[RELATIVE]
[LEVEL]
UPPER=3
LOWER=-3
FREQHI=5000
FREQLO=400
[UPPER LIMIT DATA]
200          5
300          2
```

10000	2
15000	5
[LOWER LIMIT DATA]	
200	-5
300	-2
10000	-2
15000	-5

When a level check is defined inside a limits file the QC result is actually a combination of two separate checks; one is the frequency behavior of the measurement compared against the frequency mask, the second is a level check which compares the average level of the measured curve with the average level of the reference.

The average level is calculated within the frequency extremes defined by FREQHI and FREQLO as shown in Fig.18.31a.

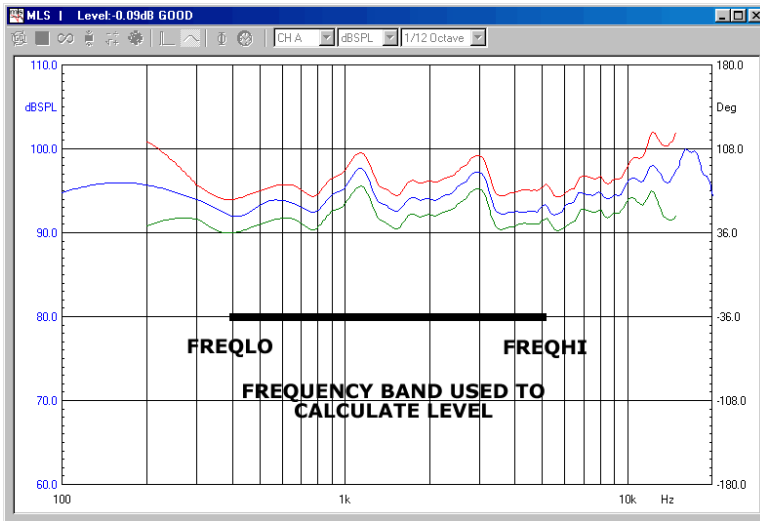

Figure 18.31a

As default, if FREQHI and FREQLO are not defined, the levels are calculated averaging in the frequency band defined by the extremes frequencies of the limits.

Fig.18.31b shows such a situation; the title of the measurement control panel reports the level check.

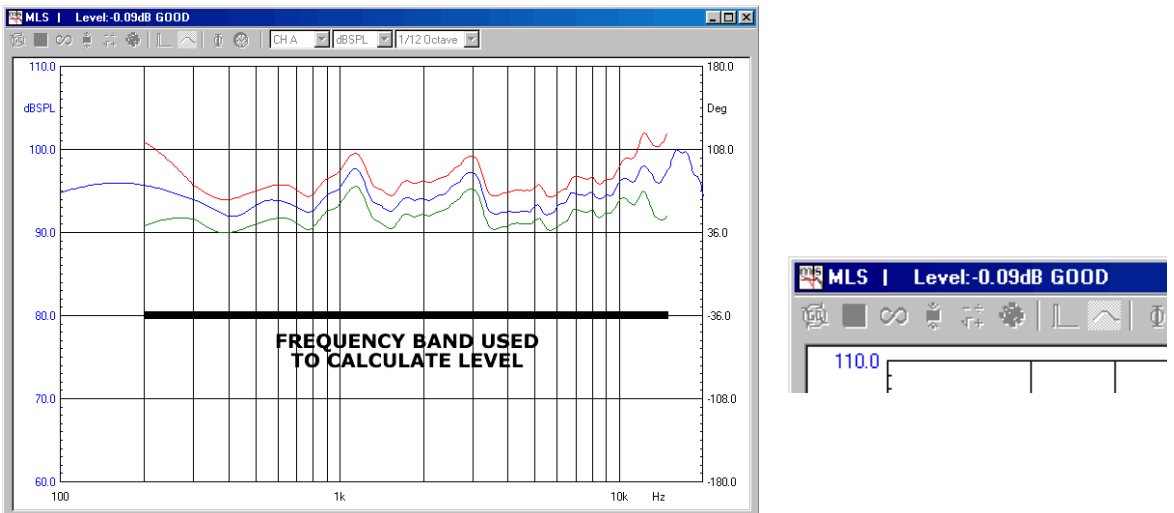

Figure 18.31b

The level check shown means that the value of the measurement averaged in the band shown is 0.09dB higher than the reference average level in the same frequency band.

**The measured curve is shifted from this value and then the frequency check is performed (see also 18.6.4).**

**The level shift means that the curve is displayed with a different level from the measured one. Refer also to Fig. 18.19.**

As two separate checks are done there may be two distinct cases when a unit results in a bad report. The following figures try to explain these two cases.

Figure 18.32 shows us the case of a unit is testing bad because the frequency behaviour is not good while the average level is OK.

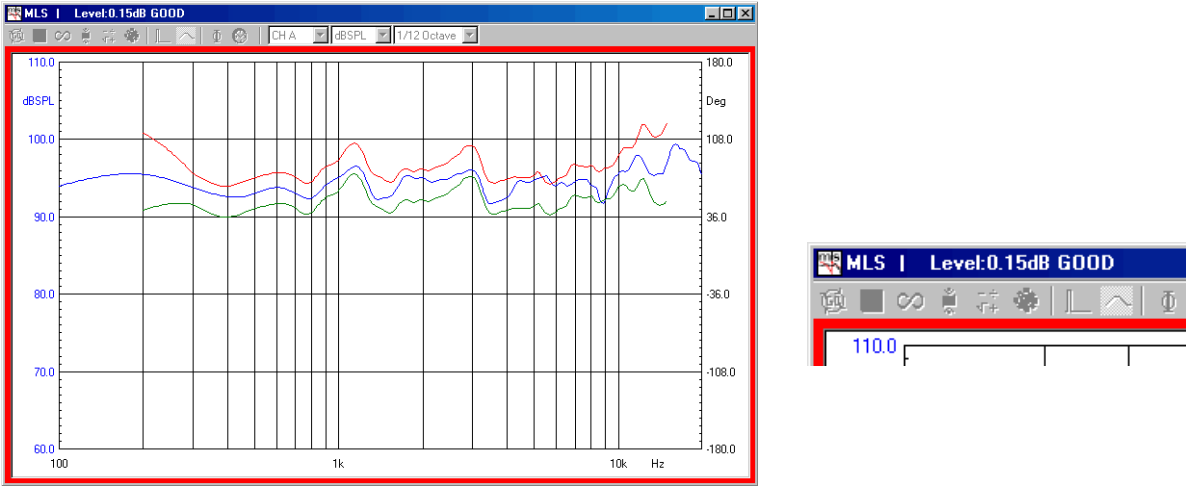

Figure 18.32

Figure 18.33, instead, shows us the case of a unit is testing bad because the average level is not good while the frequency behavior is OK.

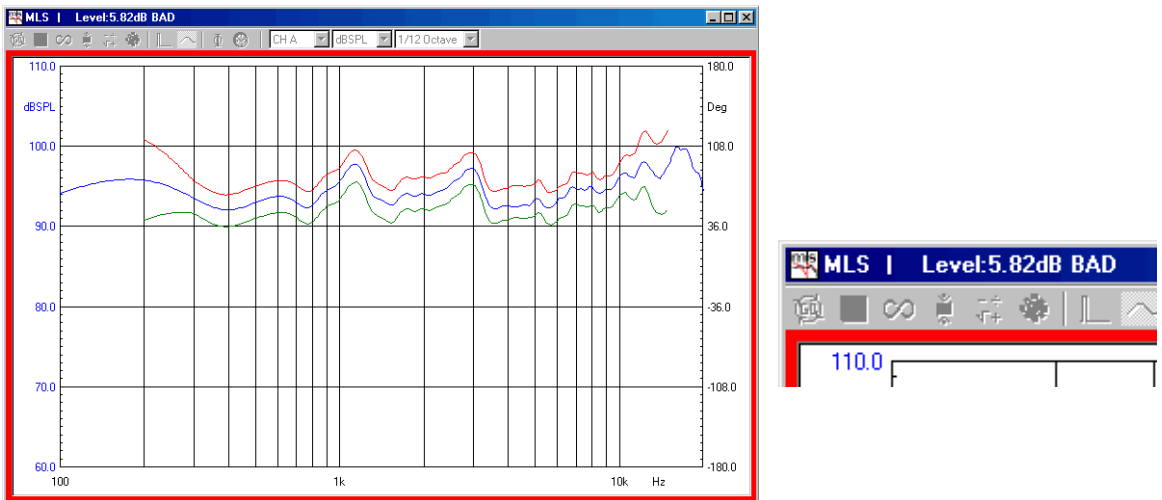

Figure 18.33

### 18.6.3 ALIGNED MASK

The following limits file defines a **single point level check with a frequency mask aligned to it**.

```
[ABSOLUTE]
[LEVEL]
UPPER=3
LOWER=-3
ALIGNFREQ=5000
ALIGNLEV=90
[UPPER LIMIT DATA]
200          5
300          2
800          2
1000         6
3000         6
4000         2
7000         2
15000        8
[LOWER LIMIT DATA]
200         -5
300         -2
10000       -2
15000       -5
```

The **align point** (in the example 90dB SPL @ 5000 Hz) is used to build the frequency mask (that is specified relative to it) and also to identify the frequency at which to perform the level check.

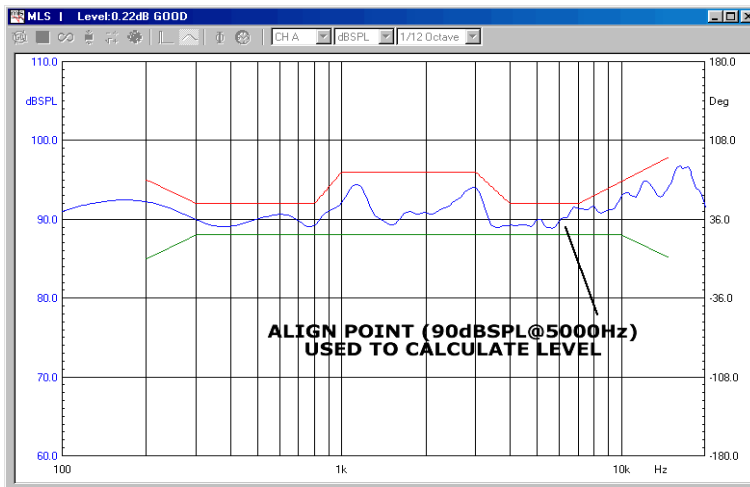

Figure 18.34

Fig. 18.34 shows a mask aligned to the point (90dB SPL @ 5000 Hz). The level check means that the value of the measurement at 5000 Hz is 0.22 dB higher than the align point.

The measured curve is shifted from this value to pass at exactly 90 dB SPL at 5000 Hz; then the frequency check is performed (see also 18.6.4).

The level shift means that the curve is displayed with a level different from the measured one. Refer also to Fig. 18.19.



## 18.6.4 SENSITIVITY CHECK

The following limits file defines a **sensitivity check** inside a relative frequency limit.

```
[RELATIVE]
[SENSITIVITY]
UPPER=102
LOWER=100
[UPPER LIMIT DATA]
200      10
500      10
1000     5
1500     5
2000     10
4000     10
[LOWER LIMIT DATA]
200      -10
500      -10
1000     -5
1500     -5
2000     -10
4000     -10
```

As per the average level check, when a sensitivity check is defined inside a limits file the QC result is actually a combination of two separate checks; one is the frequency behavior of the measurement compared against the frequency mask, the second is a sensitivity check which compares the sensitivity of the measured curve with the defined upper and lower limits.

It is possible to calculate sensitivity at discrete frequencies (up to eight) and average them together.

```
[SENSITIVITY]
FREQ1=500
FREQ2=1000
FREQ3=2000
UPPER=102
LOWER=100
```

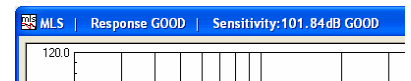
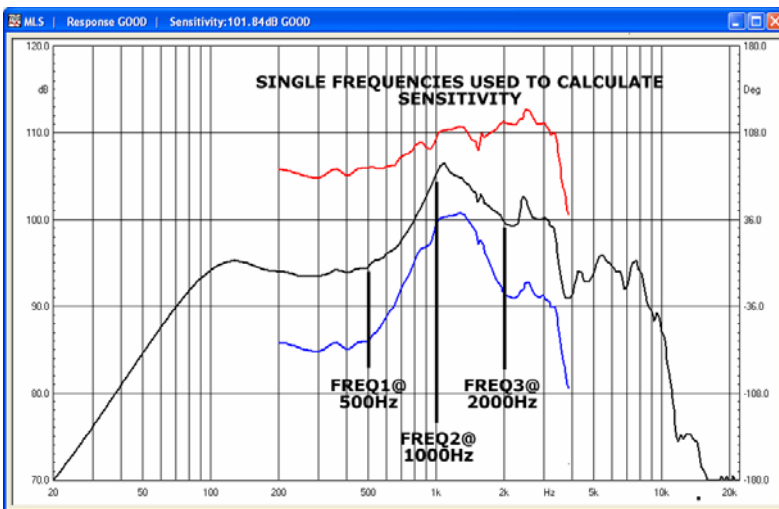

## 18.6.5 FLOATING LIMITS VS. FLOATING CURVES

When an average or single frequency level check is defined (18.6.2 or 18.6.3) it is possible to define floating limits instead of floating curves using the [FLOATING] keyword.

```
[RELATIVE]
[FLOATING]
[LEVEL]
UPPER=3
LOWER=-3
[UPPER LIMIT DATA]
200          5
300          2
10000        2
15000        5
[LOWER LIMIT DATA]
200          -5
300          -2
10000        -2
15000        -5
```

**In this case the measured curve is presented on screen with correct values while the limits curves are moved around it.**

## 18.6.6 THIELE&SMALL PARAMETERS CHECK

It is possible to execute QC tests of the following T&S parameters:

**Qt, Qe, Qm, Fs, Cms, Mms, Mmd, BI, Vas, dB SPL and ZMin.**

To evaluate the first four parameters it is necessary to input the value of the DC resistance of the voice coil with the keyword **REDC**.

To evaluate the remaining parameters, by means of a simplified estimation routine, it is necessary to input the value of the driver diameter with the keyword **DIAMETER** and one of the following fixed quantities: **KNOWNMMD** (fixed mass) or **KNOWNMMS** (fixed mass plus air load) or **KNOWNCMS** (fixed compliance).

The following limits file defines a T&S parameters check inside a limits file with a frequency mask for an impedance response. The parameters checked are **Qt, Qe, Qm** and **Fs**.

```
[TSPARAMETERS]
QTUPPER=0.3
QTLLOWER=0.05
QEUPPER=0.3
QELLOWER=0.05
QMUPPER=5
QMLLOWER=2
FSUPPER=90
FSLLOWER=50
REDC=5.5
[UPPER LIMIT DATA]
29.89          142.35
40.52          161.18
102.15         161.18
152.62        143.53
[LOWER LIMIT DATA]
29.89          11.29
49.23          20.00
64.33          45.88
76.28          47.06
98.49          22.35
141.87         11.76
```

The following section defines a T&S check of **Qts, Fs, Cms, BI** and **ZMin** having fixed the mechanical mass **Mmd** value.

```
[TSPARAMETERS]
REDC=6.2
DIAMETER=110
KNOWNMMD=10.7952
QTSUPPER=0.6
QTSLOWER=0.3
FSUPPER=90
FSLLOWER=50
CMSUPPER=1.1
CMSLOWER=0.8
BLUPPER=6.5
BLLLOWER=6
ZMINUPPER=7.5
ZMINLOWER=7
```

## 18.6.7 SINUSOIDAL THD AND HARMONICS CHECK

When executing sinusoidal frequency response measurements it is possible to activate quality control checks over single harmonic responses from the second to the fifth. This QC operation will be defined in the relative limits file as in the following example:

```
[UPPER LIMIT DATA]
1000          106
2000          116
5000          116
7000          96
[LOWER LIMIT DATA]
1000          89
2000          99
4000          99
6000          80
[3 UPPER LIMIT DATA]
300           70
500           90
2000          90
5000          70
[4 UPPER LIMIT DATA]
200           55
400           68
1300          79
2500          77
5300          77
6300          67
[THD UPPER LIMIT DATA]
200           80
1000          95
5300          95
6300          78
```

In this example we defined a check on the third and fourth harmonic with an upper limit only. It is also possible to define the lower limit but usually this is not the case. **The complete listing of the applicable keywords is in the reference section.** Fig. 18.35 shows the sinusoidal control panel after the test defined with the above limits file.

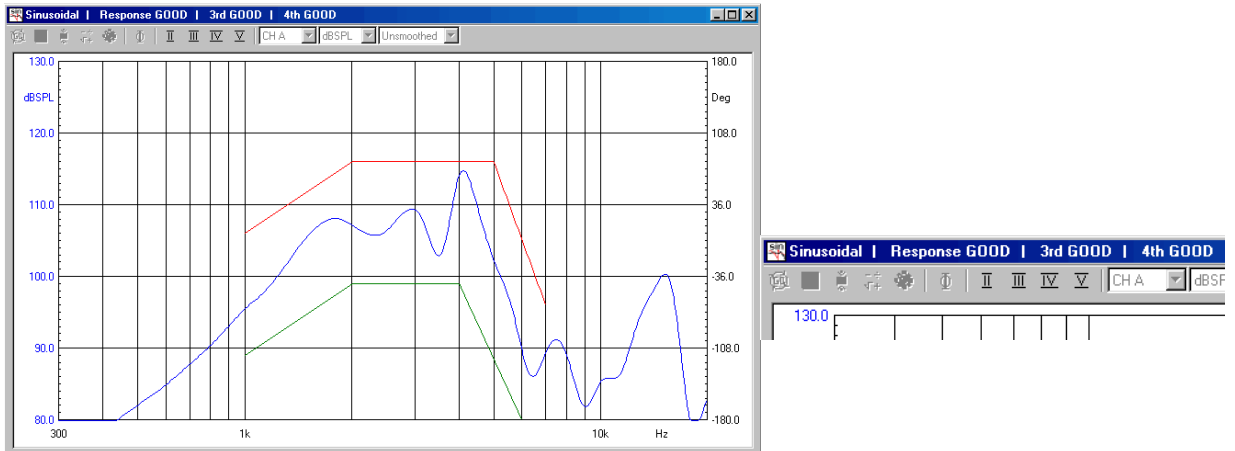

Figure 18.35

You may note that the buttons of the harmonics are now active to let you inspect them. When pressed, the relative harmonic is shown with its limits as in fig. 18.36.

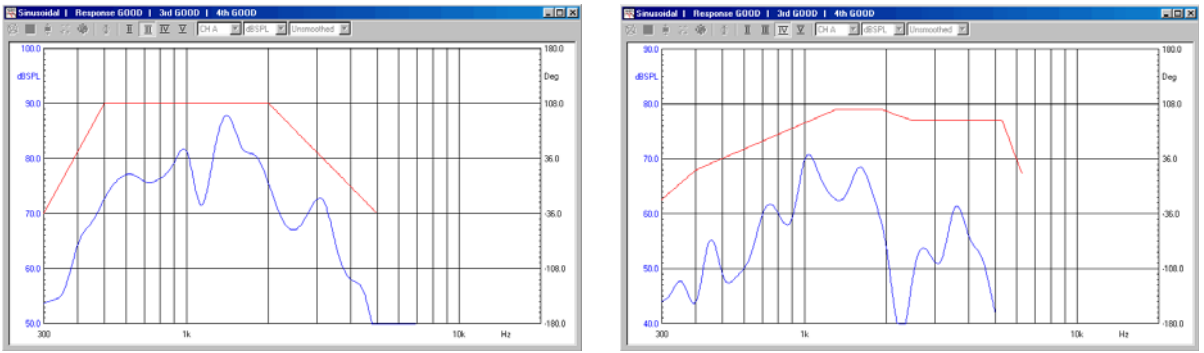

Figure 18.36

## 18.6.8 MULTIMETER LIMITS FILES

The following limits file defines a multimeter QC check.

```
[UPPER LIMIT DATA]
VOLTAGE=0.78
THD=0.01
[LOWER LIMIT DATA]
VOLTAGE=0.77
THD=0.0001
```

The parameters available are:

- PRESSURE
- VOLTAGE
- FREQUENCY
- THD
- IMD

## 18.7 MANAGING PRODUCTION BATCHES

Managing a production batch is a rather complex while delicate topic as it involves diverse needs of diverse areas inside your company.

CLIOwin QC handles your batch doing the following:

- Maintains a directory structure where different files are saved
- Automatically saves production report files
- If requested autosaves data files
- Handles 24 characters alphanumeric serial numbers
- Auto increments serial number and maintains its coherence
- Calculates statistical data about the batch

The result is that you will find the production well documented both for your internal purposes aimed to achieve the highest quality standard and also for interfacing with your client who requests technical information about the units.

### 18.7.1 DIRECTORIES CREATED BY CLIOWIN QC

Suppose you saved your script inside the directory 'My qc'. When you run the script CLIOwin automatically creates one or more directories under 'My qc'. There are four cases depending on the option you set:

- 1) No Autosave is active. A Batch is not defined.  
CLIOwin creates the 'Report' directory where all the production report files are saved. Fig.18.37 shows this situation.
- 2) Autosave is active. A SaveFolder is not defined. A Batch is not defined.  
CLIOwin creates the 'Report' directory where all the production report files are saved. It also creates the 'Autosave' directory where all data files are saved. Fig.18.38 shows this situation.

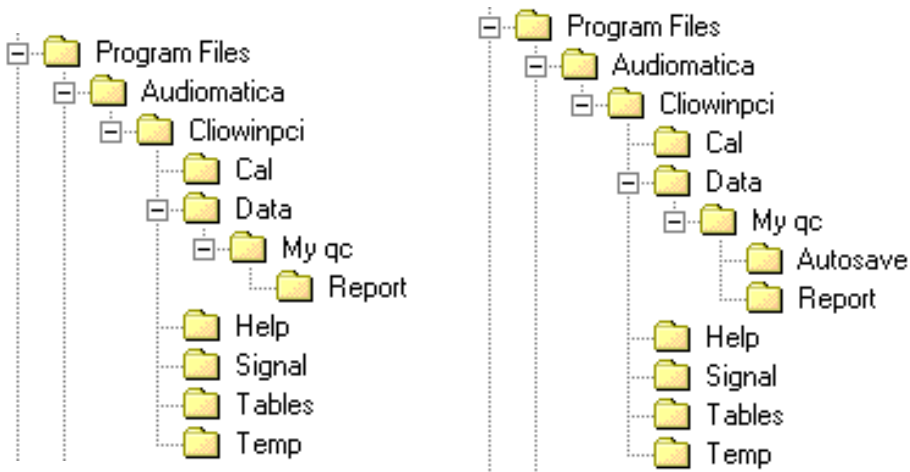

Figure 18.37 and 18.38

- 3) A Batch is defined and is named 'My Batch'. A SaveFolder is not defined.  
CLIOwin creates the 'My Batch' directory where all the production report and also data files are saved. Fig.18.39 shows this situation.
- 4) A SaveFolder is defined and is named 'My Savefolder'.  
CLIOwin creates the 'My Savefolder' directory where all the production report and also data files are saved. Fig.18.40 shows this situation.

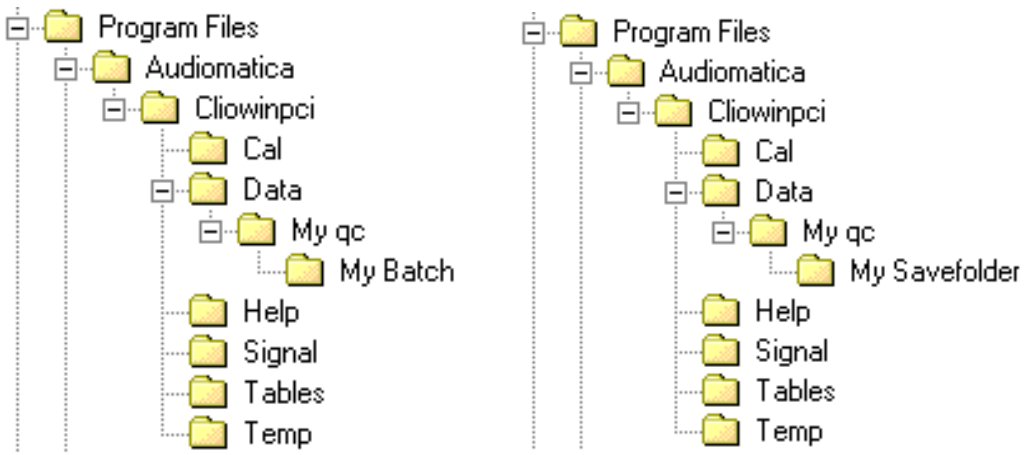

Figure 18.39 and 18.40

### 18.7.2 PRODUCTION REPORT FILES

Suppose that today, June 6, 2002, at 6:46, you started a production of your devices; the batch, named 'My Batch', ended yesterday with unit number 100.

After two units tested CLIOWin will add, under the folder 'My Batch', the following report files:

```
'production_06-06-02_6.46.18.txt'
'101.txt'
'102.txt'
```

After 20 units tested:

```
'production_06-06-02_6.46.18.txt'
'101.txt'
'102.txt'
.....
'120.txt'
```

If you stop the production, exit CLIOWin, and then restart it at 7:01, after two more units tested:

```
'production_06-06-02_6.46.18.txt'
'production_06-06-02_7.01.05.txt'
'101.txt'
'102.txt'
.....
'122.txt'
```

The files '**production\_date time.txt**' describe the QC session. They look like:

```
STATISTICS
MY COMPANY
MY QUALITY CONTROL
BATCH = My Batch
DATE = 06-06-02
INITIAL SN = 101
TOTAL TESTS = 2
GOOD = 2
BAD = 0
```

## TEST REPORT

```
UNIT N.102 GOOD 6.46.24
    1    GOOD MLS
        Response GOOD
        C:\Program files\Audiomatica\Cliowinpci\Data\My qc\My
Batch\102_1.mls
    2    GOOD MET
        Voltage:0.775Vrms GOOD
        THD:0.006% GOOD
        C:\Program files\Audiomatica\Cliowinpci\Data\My qc\My
Batch\102_2.met
UNIT N.101 GOOD 6.46.18
    1    GOOD MLS
        Response GOOD
        C:\Program files\Audiomatica\Cliowinpci\Data\My qc\My
Batch\101_1.mls
    2    GOOD MET
        Voltage:0.775Vrms GOOD
        THD:0.006% GOOD
        C:\Program files\Audiomatica\Cliowinpci\Data\My qc\My
Batch\101_2.met
```

The files '**serialnumber.txt**' describes the single QC test and look like this:

```
1 GOOD MLS
    Response GOOD
2 GOOD MET
    Voltage:0.775Vrms GOOD
    THD:0.006% GOOD
06-06-02 6.46.24
UNIT N. 102 GOOD
```

### 18.7.3 AUTOSAVED DATA FILES

Again supposing we are in the situation of the preceding paragraph let's see how data files are saved. As it can be seen from the report files our QC test consists of a MLS and a Multimeter measurement. As the MLS test is defined **before** the Multimeter inside the script then it assumes number 1 as single QC test while the Multimeter test assumes number 2; this is already clear from the report files above.

After two units tested we find the following measurement files:

```
'101_1.mls'
'101_2.met'
'102_1.mls'
'102_2.met'
```

As you see the QC **single test numbering** is integral part of the name of the autosaved data file.

### 18.7.4 WYSIWYG OPERATION

Wysiwyg (i.e. "what you see is what you get") operation is the way the QC processor saves and exports data files while executing quality control. Setting WYSIWYG=1 under

[GLOBALS] results in files saved as you see them on screen, with all the processing peculiar to QC applied. For example if a frequency response is executed with MODE=DIFFERENCE active (i.e. divided by the reference) than the saved file will be divided by the reference, if wysiwyg is active, otherwise not.

### 18.7.5 STATISTICAL INFORMATION ON MEASURED DATA

Statistical information characterizing the production can be obtained by CLIOwin using the STATISTICS keyword under [GLOBALS].

CLIOwin will save, under the report directory, the following files:

- One file named '**data\_table.txt**' with statistical information on all the measured parameters.
- One file named '**avg\_testnumber.txt**' for each response test defined containing the average response for that test.
- One file named '**sdmax\_testnumber.txt**' for each response test defined containing the average response plus twice the standard deviation for that test.
- One file named '**sdmin\_testnumber.txt**' for each response test defined containing the average response minus twice the standard deviation for that test.

**The statistical files keep track of the all the units saved within a batch even if the production is stopped and then restarted.**

Let's now see what the 'data\_table.txt' looks like; supposing the same case of 18.7.2, after two tests, we would have the following:

```
SN Voltage THD
101 0.775 0.006
102 0.775 0.006
```

```
Avg 0.775 0.006
SDMax 0.776 0.006
SDMin 0.775 0.006
```

The other response files representing average and standard deviation curves may be imported within each control panel with the Import feature recallable with **Shift-F3**.

## 18.7.6 SERIAL NUMBER MANAGEMENT

There are several ways to handle the serial numbers of your devices and to maintain their coherence through all the production of one batch.

Two different strategies are possible with respect to serial number management:  
1 - CLIOwin handles and manages an **8-digit numeric** serial number. This is the default operation.

2 - CLIOwin accepts a **24 characters alphanumeric** serial number; its management is left to the user.

To activate the second option use the AUTOSN=0 keyword (default is AUTOSN=1).

```
[GLOBALS]
```

```
...
```

```
AUTOSN=0
```

```
...
```

```
...
```

```
[SNINPUT]
```

The operator is prompted for serial number input using the [SNINPUT] keyword. Input can be done with any kind of bar code reader.

It is also possible to manually input the serial number before starting the test; to do this just click on the  button.

Under default operation (AUTOSN=1) the 8-digit serial number is automatically increased after the end of the test. It is possible to avoid a bad unit increasing the serial number using the INCREASEONBAD=0 keyword.

**Set INCREASEONBAD=0 if you want only good units to have a serial number, report, statistical and autosave management; this works also when AUTOSN=0.**

The operator, under her or his judgment, can force the final result of a bad test if the keyword PROMPTFORGOOD=1 is used.

## 18.7.6 THE SKIP LAST BUTTON

When a QC test is finished it is also possible to null its result by pressing the Skip Last  button. All information saved with the test will be erased comprising serial number increment and statistical data. The production report will mark the unit as 'SKIPPED'.

## 18.8 INTERACTING WITH EXTERNAL HARDWARE

The interaction with external hardware gives CLIOwin the possibility of realizing semi or fully automatic production line QC tests. Several keywords have been introduced to implement this functionality (see to reference section for a complete listing).

### 18.8.1 INPUT SENSITIVITY AND OUTPUT VOLTAGE CONTROL

As we have already seen it is of fundamental importance to correctly set CLIO's input sensitivity and output level (see 4.5). The IN and OUT keywords are used for this. The script below sets the input sensitivity at 10dBV and output level at 0dBu. These numbers also directly appear also in the main tool bar of CLIOwin.

```
...
IN=10
OUT=0
...
```

The OUTUNITS keyword can be used, under [GLOBALS], to define the output level unit of measure; you may choose either V, dBV or dBu; default is dBu. To output 1V simply write:

```
[GLOBALS]
OUTUNITS=V
...
OUT=1
...
```

If you feed the output to a power amplifier the resulting signal at amplifier terminals will be amplified by the gain of the amplifier. It is possible to take this effect into account and specify the output level directly at the amplifier in this particular case you are using a CLIOQC Amplifier & SwitchBox. The following script can be used to set 2.83V at the output of the amplifier.

```
[GLOBALS]
OUTUNITS=V
...
OUTQCBOX=2.83
...
```

### 18.8.2 SC-01 DC OUTPUT CONTROL

The SC-01 Signal Conditioner has the capability of superimposing a DC voltage to the generated signal (see 4.5.3). It is possible to manage this DC voltage with the DCON and DCV keywords. The script below sets a 0.5V DC at SC-01 channel A output.

```
[PERFORM]
DCV=0.5
DCON=1
```

If you feed the output of the SC-01 to a DC coupled amplifier the resulting DC voltage, if present, at amplifier terminals will be amplified by the gain of the amplifier. It is possible to take this effect into account and specify the DC voltage directly at the amplifier in

the particular case you are using a CLIOQC Amplifier & SwitchBox. The following script can be used to have 5V DC at the output of the amplifier.

```
[PERFORM]
DCVQCBOX=5
DCON=1
```

### 18.8.3 CLIOQC AMPLIFIER&SWITCHBOX CONTROL

Using a CLIOQC amplifier & switchbox it is possible to setup a powerful QC environment like the one depicted in the example 6 (see 18.9.6) where the simultaneous control of near and far field responses and impedance is shown.

Custom controls have been implemented to easily control all the internal functions of this unit:

- [SETINPUT1] Selects input 1 of the CLIOQC Amplifier & SwitchBox.
- [SETINPUT2] Selects input 2 of the CLIOQC Amplifier & SwitchBox.
- [SETINPUT3] Selects input 3 of the CLIOQC Amplifier & SwitchBox.
- [SETINPUT4] Selects input 4 of the CLIOQC Amplifier & SwitchBox.
- [SETINPUT5] Selects input 5 of the CLIOQC Amplifier & SwitchBox.
- [SETINPUT6] Selects input 6 of the CLIOQC Amplifier & SwitchBox.
- [SETINPUT7] Selects input 7 of the CLIOQC Amplifier & SwitchBox.
- [SETINPUT8] Selects input 8 of the CLIOQC Amplifier & SwitchBox.
- [SETIMPEDANCE] Selects impedance mode of the CLIOQC Amplifier & SwitchBox.
- [SETISENSE] Selects I Sense mode of the CLIOQC Amplifier & SwitchBox.

### 18.8.4 EXTERNAL TRIGGER

It is possible to trigger the QC tests sequence with an external TTL signal wired to the PC parallel printer port. This operation is controlled by the External Trigger button in the QC control panel and by the **MANUAL** keyword inside the QC script.

Fig.18.41 shows a foot pedal switch and shows its connection to the PC to enable the control of the QC test.

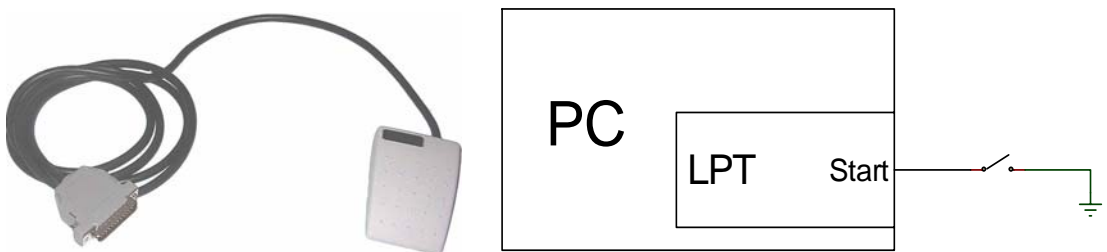

Figure 18.41

The QCBox Model4 has a dedicated input 'PEDAL IN' that can be used to connect the external foot pedal or trigger signal.



The following lines are needed inside a script file to enable a switch (or externally generated TTL signal) to start and continue a QC measurement.

```
[GLOBALS]
...
...
MANUAL=0
```

Please refer to 18.8.7 and to the commands reference for more details on TTL input signal management.

### 18.8.5 TTL SIGNALS GENERATION

It is possible to define the status of the bits of the active parallel port thus generating TTL signals controlled by the software; the following is a list of the kind of signals possible:

- signals output at startup (INITIALBITS)
- signals conditioned by the result of a single measure ([IF LAST GOOD], [IF LAST BAD])
- signals conditioned by the global result ([IF ALL GOOD], [IF ALL BAD])
- unconditioned signals ([PERFORM])

Let's see an example of generation of external signals conditioned by the result of the measurement:

```
[GLOBALS]
...
...
INITIALBITS=0
[FFT]
...
...
[MLS]
...
...
[IF LAST BAD]
BIT=3
BITVALUE=1
DELAY=200
[IF LAST GOOD]
BIT=3
BITVALUE=0
DELAY=200
[IF ALL GOOD]
BIT=1
BITVALUE=1
[PERFORM]
BIT=0
BITVALUE=1
```

```

DELAY=200
[PERFORM]
8BITVALUE=0

```

This example defines a signal high on bit 3 if the MLS test performs bad, a signal high on bit 1 if all the tests are OK and an unconditioned pulse of 200 ms on bit 0 that may be used to signal the end of the QC test sequence.

Referring to Figure 18.42 we can see the time signal of the three bits in the two possible cases A and B; in case A the MLS test performed bad and in case B good.

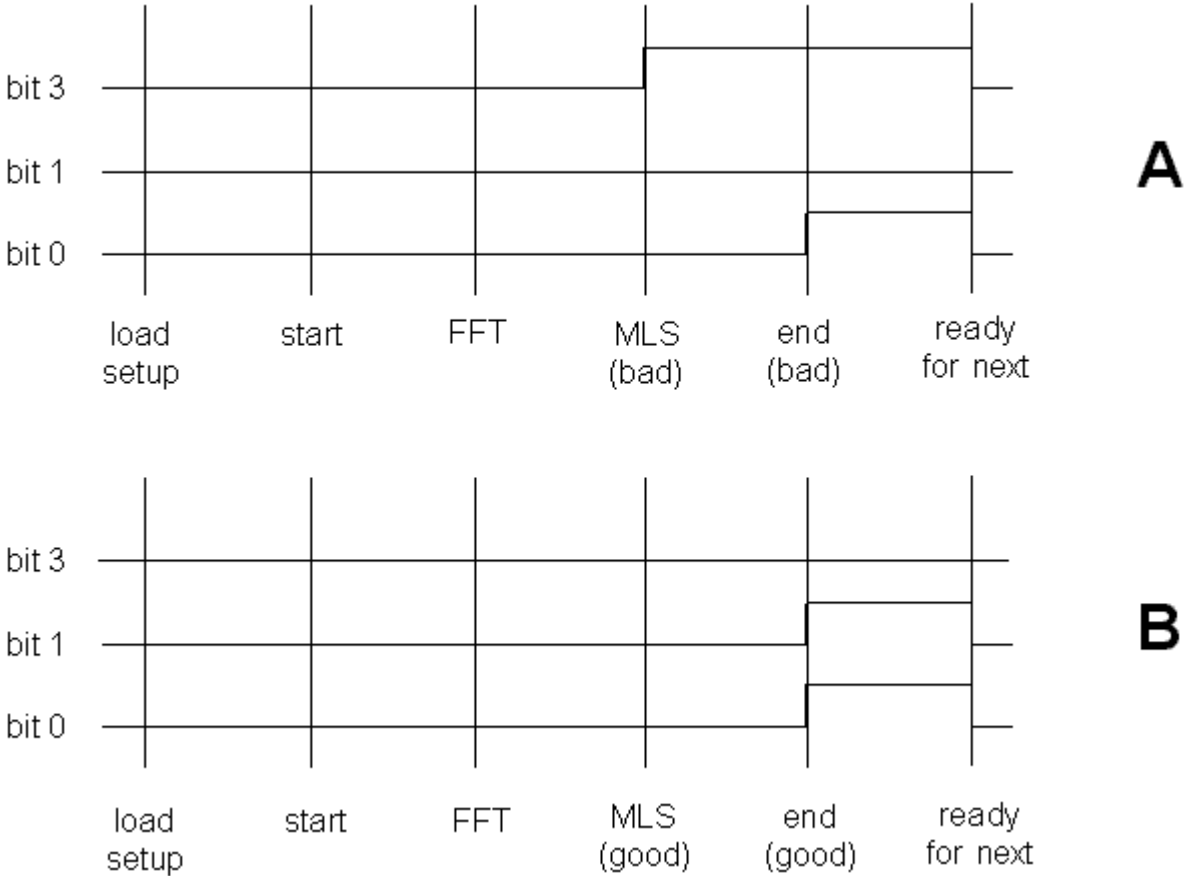

Figure 18.42

In the example shown each single bit of the parallel port was controlled separately by means of the BIT and BITVALUE keywords; it is also shown how to simultaneously control the 8 bits with the 8BITVALUE keyword.

In the next example the value of 33 (decimal) is directly output, thus setting bits 0 and 4 to one and all the others to zero.

```

[PERFORM]
8BITVALUE=33

```

### 18.8.6 TIME DELAYS GENERATION

It is possible to define a time delay in any point of a script file with the following definition:

```

[PERFORM]
DELAY=200

```

In this example the QC sequence waits for 200 millisecond when encountering these keywords. In the previous paragraph you can also see the possibility of mixing time delays with signals definitions in order to generate pulses.

### 18.8.7 PARALLEL PORT SIGNALS MANAGEMENT

The TTL signals generated with the active parallel printer port of the PC may be interactively controlled by means of the External Hardware menu recallable with **Shift-F4**. After opening this box press the Direct TTL Control button  and you obtain the control panel shown in fig 18.43. To get TTL signals operation please select a parallel port from the ones available.

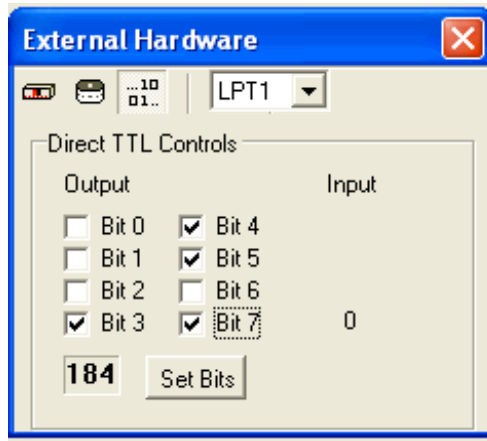

Figure 18.43

The Direct TTL Controls dialog lets you set the status of the eight output bits using the appropriate check boxes while triggering it with the Set Bits button; a decimal representation of the output binary word is also present. On the left side the status of the input start bit is reported.

The pin-out of the standard parallel port is shown in fig.18.44; note the eight output bits and the start trigger pulse in input.

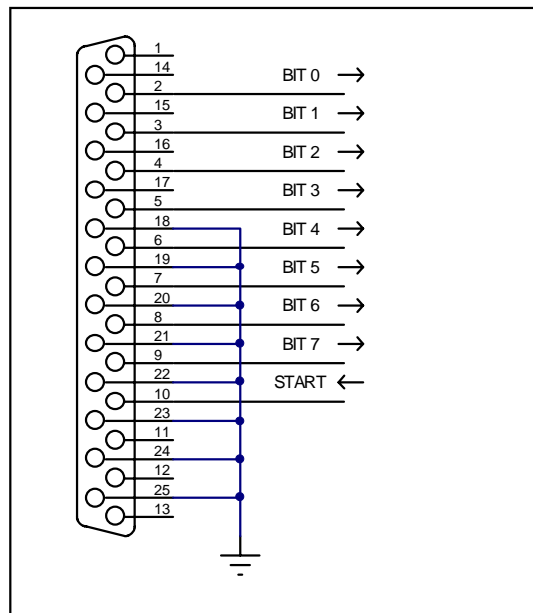

Figure 18.44

## 18.8.6 RS-232 SERIAL PORT CONTROL

During QC execution it is possible to control serial devices, like label printers, connected via an RS-232 link to your PC. You can select and configure a COM port for QC control within the File>Setup>QC panel (see 6.3.6).

The following script can be used to print a label at the end of a QC test if the result of the test is good; the printing commands refer to a Zebra Z4M printer.

```
[GLOBALS]
OPENSERIAL=1
SERIALMONITOR=1
...
...
...
...
...
[IF ALL GOOD]
SERIALOUT=^XA^LH40,100,^F020,10^AD^FD@SERIALNUMBER^FS^XZ
```

Note the @SERIALNUMBER acronym that is used to output the current serial number. It is possible to activate, mainly for debugging purposes, a monitor window that echoes RS-232 activity; to do this use the SERIALMONITOR keyword.

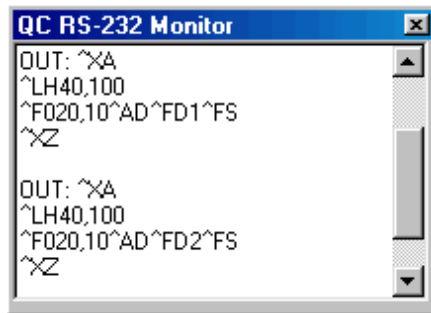

The same text output in the above example could be saved in an ASCII file and loaded with the SERIALOUTFILE keyword:

```
...
...
[IF ALL GOOD]
SERIALOUTFILE=SERIAL.TXT
```

## 18.9 LEARNING CLIOWIN QC WITH EXAMPLES

### 18.9.1 EXAMPLE 1: QC OF A MICROPHONE PREAMPLIFIER

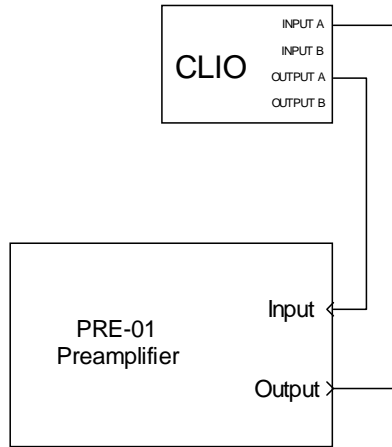

Figure 18.45

This example is taken from our internal QC procedure for the PRE-01 Microphone Preamplifier. Figure 18.45 shows the connections required. The PRE-01 features three weighting filters and two gain positions. This test is a representative case of the following requirements:

- 1) The limits are **ABSOLUTE** as they are taken from the IEC tables for the specified tolerance. Since the perfect device has still to be built it is not possible to use relative limits from a real life measured reference.
- 2) The IEC specifies a response in term of a 0 dB at 1kHz. The absolute level at 1kHz is however left to the test procedure. As we want to perform the test near the highest level the device is able of accept, we need to use the **PROCESS** feature to shift the real measurement to the specs level.
- 3) Changes in switch position are required during test. We have therefore to use the **INTERACTIVE** feature.
- 4) A level regulation is required to align the gain at 1kHz with and without a filter. This brings in the **LOOP** feature of the [MET] multimeter test.
- 5) It's very difficult for the operator to set a switch accordingly to the next test to be performed. The **PERFORM** and **MESSAGE** feature greatly simplifies this, avoiding errors.

The QC script, described here with comments, allows the check of the filters response against Type 1 tolerance specification. It also checks for +/- 0.2 dB gain tolerance of the gain switch in both positions. As an additional feature it allows the user, within the test, to adjust a variable gain trimmer that has to be adjusted to achieve optimum levels; this procedure, **LOOP**, also ends with a check of the adjusted level to be within +/- 0.2 dB. At every level check a distortion test, **THD** defined in the LEV1.LIM file, is performed. As a general rule a QC procedure is defined from one QC file (.qc extension) and several limits file (.lim extension) declared in the qc file. Process files (.mpro or .spro) are also involved here and these are the only ones not specifically QC related. It is a good idea to dedicate a directory for each QC test. The files involved here are:

PRE01.QC

LEV1.LIM  
A.LIM  
B.LIM  
C.LIM  
ASHIFT.SPRO

You can find them in the '**\DATA\EXAMPLE1**' directory under the installation directory.

```
[GLOBALS]
COMPANY=AUDIOMATICA S.R.L. FLORENCE
TITLE=PRE01 TEST PROCEDURE
INTERACTIVE=1
SAVEONBAD=1
```

```
[PERFORM]
MESSAGE=FILTER OFF DIP ON OFF OFF OFF
```

```
[MET]
OUT=2.44
IN=10
REFERENCE=FILTER.MET
LIMITS=LEV1.LIM
```

```
[PERFORM]
MESSAGE=FILTER ON DIP ON OFF OFF OFF
```

```
[MET]
OUT=2.44
IN=10
REFERENCE=FILTER.MET
LIMITS=LEV1.LIM
LOOP=1
```

```
[PERFORM]
MESSAGE=FILTER ON DIP ON OFF OFF ON
```

```
[MET]
OUT=-17.56
IN=10
REFERENCE=FILTER.MET
LIMITS=LEV1.LIM
```

```
[SIN]
OUT=-10
IN=10
REFERENCE=A.SIN
LIMITS=A.LIM
PROCESS=ASHIFT.SPRO
```

```
[PERFORM]
MESSAGE=FILTER ON DIP OFF ON OFF ON
```

```
[SIN]
OUT=-10
IN=10
```

REFERENCE=A.SIN  
LIMITS=B.LIM  
PROCESS=ASHIFT.SPRO

[PERFORM]

MESSAGE=FILTER ON DIP OFF OFF ON ON

[SIN]

OUT=-10

IN=10

REFERENCE=A.SIN

LIMITS=C.LIM

PROCESS=ASHIFT.SPRO

[PERFORM]

MESSAGE=SET DEFAULT SETTINGS FILTER OFF DIP ON OFF OFF ON

## 18.9.2 EXAMPLE 2: THE AMPLIFIER&SWITCHBOX UNDER QC

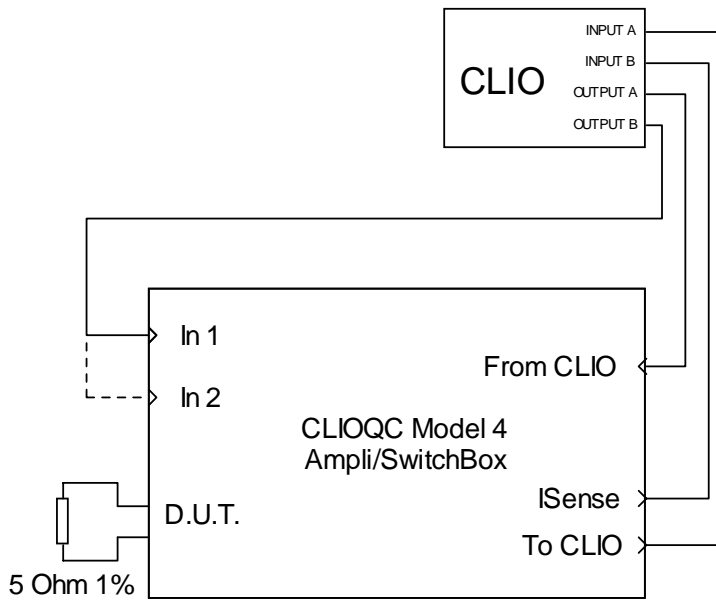

Figure 18.46

This example details the quality control procedure that Audiomatica uses to test its production of CLIOQC Amplifier & Switchbox.

A precision 10 Ohm 2W 1% resistor is needed and must be connected across DUT terminals. The procedure, executed in Interactive mode, guides the operator and requests the manual connection of the unit; the cable coming from output B of CLIO must be swapped during the test between input 1 and 2.

The test begins with two impedance measurements, the first executed in ISense Mode, the second executed in Internal Mode. Then a THD measurement with FFT and finally the frequency response of each input channel are performed.

Note the keywords used to alternatively mute CLIO's output.

```
[GLOBALS]
COMPANY=AUDIOMATICA S.R.L. FLORENCE
TITLE=QCBOX TEST PROCEDURE
INTERACTIVE=1

[PROMPT]
MESSAGE=CONNECT:
MESSAGE2=[OUTA->FROM CLIO][INA->TO CLIO][OUTB->CH1][INB->ISENSE]

[PROMPT]
MESSAGE=PLACE 5 OHM 1% RESISTOR ACROSS D.U.T. TERMINALS

[SETIMPEDANCE]
[SETMUTEB]

[PERFORM]
DELAY=500
```

```
[SIN]
OUT=0
```

```
IN=-20  
REFERENCE=IMPEDANCE.SINI  
LIMITS=IMPEDANCE.LIM
```

```
[SETINPUT1]
```

```
[PERFORM]  
DELAY=500
```

```
[SIN]
OUT=10
IN=-20
REFERENCE=ISENSE.SINI
LIMITS=IMPEDANCE.LIM
```

```
[FFT]
OUT=10.0
IN=-10
ACQUISITIONDELAY=200
REFERENCE=FFT.FFT
LIMITS=FFT.LIM
```

```
[RESETMUTEB]
[SETMUTEA]
```

```
[PERFORM]
DELAY=500
```

```
[SIN]
OUT=10
IN=10
REFERENCE=CH.SIN
LIMITS=CH.LIM
```

```
[PROMPT]
MESSAGE=CONNECT:
MESSAGE2=[OUTB -> CH2]
```

```
[SETINPUT2]
```

```
[PERFORM]
DELAY=500
```

```
[SIN]
REFERENCE=CH.SIN
LIMITS=CH.LIM
```

```
[RESETMUTEA]
```

You can find the files of this example in the '**\DATA\EXAMPLE2**' directory under the installation directory.

### 18.9.3 EXAMPLE 3: A FOUR-WAYS CROSSOVER

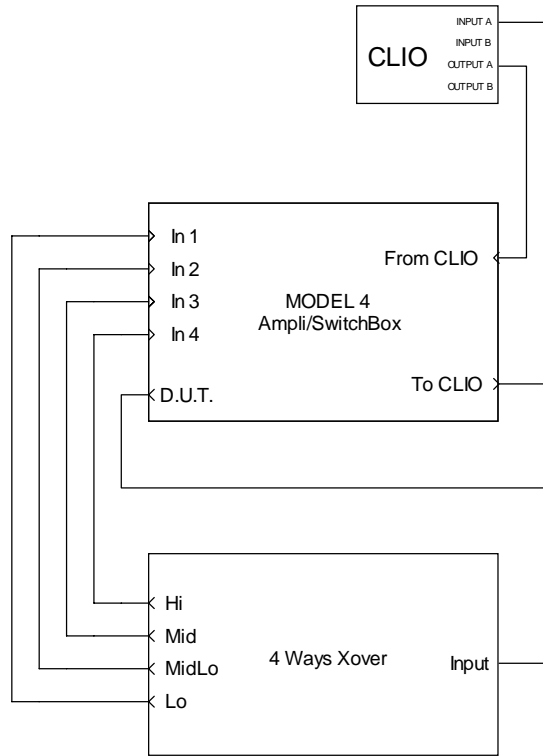

Figure 18.47

The test setup of Fig.18.47 shows us the application of an 8 input CLIOQC Model3 Amplifier & Switchbox to assess the quality of a production of a 4-way crossover.

The following self-explaining script implements the procedure required to test the frequency response of each branch of the filter; please note the unique input and output settings under [GLOBALS].

```
[GLOBALS]
COMPANY=MY COMPANY
TITLE=4-WAY CROSSOVER QUALITY CONTROL
OUTQCBOX=10.0
IN=10
```

```
[SETINPUT1]
```

```
[MLS]
REFERENCE=LO.MLS
LIMITS=LO.LIM
```

```
[SETINPUT2]
```

```
[MLS]
REFERENCE=MIDLO.MLS
LIMITS=MIDLO.LIM
```

```
[SETINPUT3]
```

```
[MLS]
REFERENCE=MID.MLS
```

```
LIMITS=MID.LIM
```

```
[SETINPUT4]
```

```
[MLS]
```

```
REFERENCE=HI.MLS
```

```
LIMITS=HI.LIM
```

You can find the files of this example in the '**\DATA\EXAMPLE3**' directory under the installation directory.

## 18.9.4 EXAMPLE 4: A MEDIUM SIZED PRODUCTION OF A 13CM DRIVER

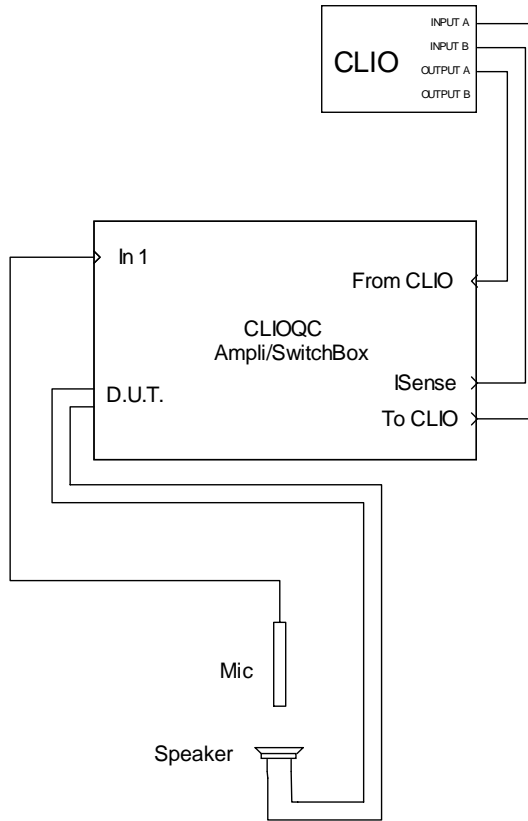

Figure 18.48

We describe here the quality control test of the production of a 13cm woofer (Fig. 18.48).

This procedure accounts for:

- A) Frequency response measurement
- B) Sensitivity check
- C) Impedance measurement
- D) T&S parameters check
- E) Batch management with statistics
- F) Autosaving of all measured drivers

```
[GLOBALS]
COMPANY=MY COMPANY
TITLE=133MM DRIVER QUALITY CONTROL
AUTOBATCH=1
STATISTICS=1
AUTOSAVE=1
```

```
[SETINPUT1]
```

```
[SIN]
OUTQCBOX=10.0
IN=10
REFERENCE=RESPONSE.SIN
LIMITS=RESPONSE.LIM
```

```
[SETISENSE]
```

```
[SIN]
```

```
OUTQCBOX=10.0
```

```
IN=10
```

```
REFERENCE=IMPEDANCE.SINI
```

```
LIMITS=IMPEDANCE.LIM
```

Inside the '**RESPONSE.LIM**' file we find the section defining the sensitivity check.

```
[LEVEL]
```

```
UPPER=3
```

```
LOWER=-3
```

Inside the '**IMPEDANCE.LIM**' file we find the section defining the T&S parameters check; with the **KNOWNMMD** keyword we implement the simplified estimation method fixing the driver's mass value. The parameters tested are Fs, Qts, Vas, Bl, Cms and Zmin.

```
[TSPARAMETERS]
```

```
REDC=3
```

```
DIAMETER=133
```

```
KNOWNMMD=19.75
```

```
FSUPPER=55
```

```
FSLOWER=45
```

```
QTSUPPER=0.6
```

```
QTSLOWER=0.3
```

```
BLUPPER=7
```

```
BLOWER=5
```

```
ZMINUPPER=5
```

```
ZMINLOWER=3
```

```
VASUPPER=13
```

```
VASLOWER=10
```

```
CMSUPPER=0.6
```

```
CMSLOWER=0.3
```

You can find the files of this example in the '**DATA\EXAMPLE4**' directory under the installation directory.

## 18.9.5 EXAMPLE 5: A LARGE SIZED PRODUCTION OF A 2CM TELEPHONE SPEAKER

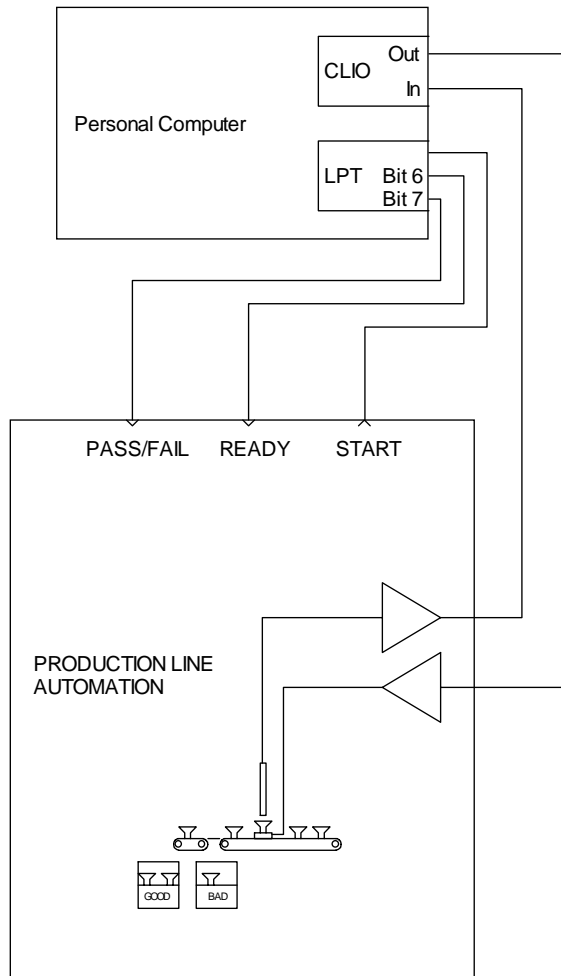

Figure 18.49

We describe here the quality control test of the production of a 2cm telephone speaker.

The test setup, in Fig. 18.49, shows us a fully automatic test environment where CLIO is interacting with a production line automation controller.

The automatic interaction is instructed with the **MANUAL** keyword which tells the QC processor to start when triggered by the external automation; on the other end the signals generated by CLIO tell to the automation controller the result of the test and the ready status.

```
[GLOBALS]
MANUAL=0
INITIALBITS=0
OUT=-3.0
IN=10
```

```
[MLS]
REFERENCE=RESPONSE.MLS
LIMITS=RESPONSE.LIM
POLARITY=1
```

```
[IF ALL GOOD]
```

```
BIT=7  
BITVALUE=0
```

```
[IF ALL BAD]  
BIT=7  
BITVALUE=1
```

```
[PERFORM]  
DELAY=1000  
BIT=7  
BITVALUE=0
```

```
[PERFORM]  
BIT=6  
BITVALUE=1
```

```
[PERFORM]  
DELAY=1000  
BIT=6  
BITVALUE=0
```

You can find the files of this example in the '**DATA\EXAMPLE5**' directory under the installation directory.

## 18.9.6 EXAMPLE 6: A CYCLIC SCRIPT (USED TO MANAGE MY ROGERS LS3/5A TWO-WAY LOUDSPEAKER PRODUCTION)

This example describes a hardware and software setup to do quality control over a production of loudspeakers units; the responses are taken come from our samples of Rogers LS3/5A speakers. The hardware setup is shown in Fig.18.50

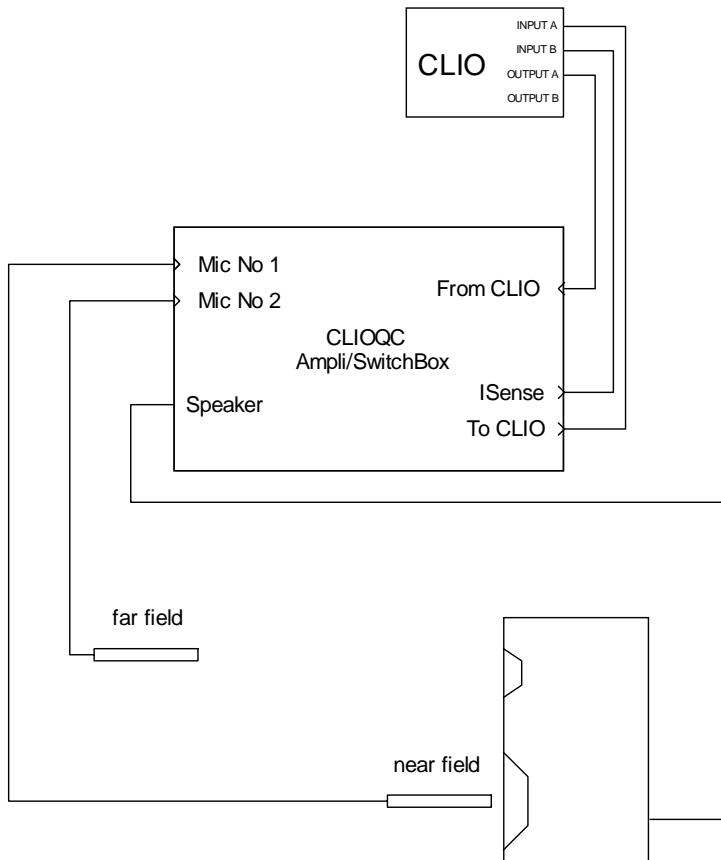

Figure 18.50

As you can see we employ a CLIOQC Amplifier & SwitchBox that connects two measuring microphones, one for near field response and the other for far field response. The internal switcher is used to configure impedance with current sensing or frequency response measurements and to select the correct microphone.

The quality control of such a production relies on what is called **a reference loudspeaker** i.e. a unit which is kept aside the line and retested regularly to give reference data curves for the units under test. These data trace environmental conditions.

To accomplish the recurrent operation of testing the reference loudspeaker CLIOwin QC implements what is called the **cyclic script** i.e. a QC script that is launched by the main script on a timed basis and executed once. When the cyclic script is launched the operator is prompted and the reference unit must be placed on the line.

The three keywords used to define this operation are CYCLIC, REPETITION and CYCLICFIRST under [GLOBALS]. CYCLIC defines the name of the cyclic script; this file must reside in the same directory of the calling one. REPETITION defines after how many units it is run; we put 4 in the example only to allow you to test it, this number is chosen after evaluating the particular condition of the production line. CYCLICFIRST, which in the example is commented away, tells the software to execute the cyclic script **before**

the first run of the main script; this is useful to set known conditions at the beginning of a QC session.

```
[GLOBALS]
CYCLIC=ROGERSCYCL.QC
;CYCLICFIRST=1
REPETITION=4
OUTUNITS=V
OUTQCBOX=2.83
IN=-20
```

Please note the use of the **OUTUNITS** keyword which accounts for output levels expressed in Volts RMS. With **OUTQCBOX=2.83** we chose to set 2.83 Volts at Rogers terminals.

The rest of the main script for producing my LS3/5As deals with the three actual measurements for testing nearfield, farfield and impedance data; the first two are done with MLS, the third with Sinusoidal. Before each measurement definition are the relative commands that set the correct function of the Amplifier & SwitchBox; note that the impedance is done in 'ISense' mode.

```
[SETINPUT1]

[MLS]
REFERENCE=NEARFIELD.MLS
LIMITS=NEARFIELD.LIM

[SETINPUT2]

[MLS]
REFERENCE=FARFIELD.MLS
LIMITS=FARFIELD.LIM

[SETISENSE]

[SIN]
OUTQCBOX=1
IN=-30
REFERENCE=IMPEDANCE.SINI
LIMITS=IMPEDANCE.LIM
```

The main QC script ends here. It is a fairly simple one, which can be customized for any production of loudspeakers. Let's now see the cyclic script. The basic idea is to execute the same measurements as in the main script and save them with the names of the reference files for the main script itself. AUTOSAVE=1 prepares for saving all the measurements done; SAVEFOLDER= is a particular syntax to set the script directory as the current one.

```
[GLOBALS]
AUTOSAVE=1
SAVEFOLDER=
OUTUNITS=V
OUTQCBOX=2.83
IN=-20
```

The rest of the cyclic script resembles the main script with the difference that after each measurement, we define the name of the file to be saved and force it to be equal to the name of the reference file; in this way the reference file itself is updated. SAVEPROMPT=1 instructs the QC processor to prompt for user acceptance of the save operation; this is useful for validating the procedure and avoiding errors.

```
[SETINPUT1]
```

```
[MLS]
```

```
REFERENCE=NEARFIELD.MLS  
LIMITS=NEARFIELD.LIM  
SAVENAME=NEARFIELD  
SAVEPROMPT=1
```

```
[SETINPUT2]
```

```
[MLS]
```

```
REFERENCE=FARFIELD.MLS  
LIMITS=FARFIELD.LIM  
SAVENAME=FARFIELD  
SAVEPROMPT=1
```

```
[SETISENSE]
```

```
[SIN]
```

```
OUTQCBOX=1  
IN=-30  
REFERENCE=IMPEDANCE.SINI  
LIMITS=IMPEDANCE.LIM  
SAVENAME=IMPEDANCE  
SAVEPROMPT=1
```

You can find the files of this example in the '**DATA\EXAMPLE6**' directory under the installation directory.

## 18.9.7 EXAMPLE 7: RUB & BUZZ DETECTION (1)

This example describes an effective technique to detect rub&buzz in a production line of loudspeakers. The technique is based on logarithmic chirp stimulus with synchronous FFT detection.

CLIOwin is able to generate (see 7.7) logarithmic chirps of proper length and proper start and stop frequencies.

Given your production of speakers you should program the log chirp following these guidelines:

**Frequency Range.** The frequency extremes depend on the kind of speaker; the start frequency must be below the resonant frequency ( $F_s$ ) to achieve excursion while the stop frequency should be high enough to stimulate all possible defects and anomalous mechanical contacts. We suggest start to lie between **20Hz/100Hz** while stop between **500Hz/1500Hz**. Stop should be a compromise between best defect detection and anomalous resonances excitation.

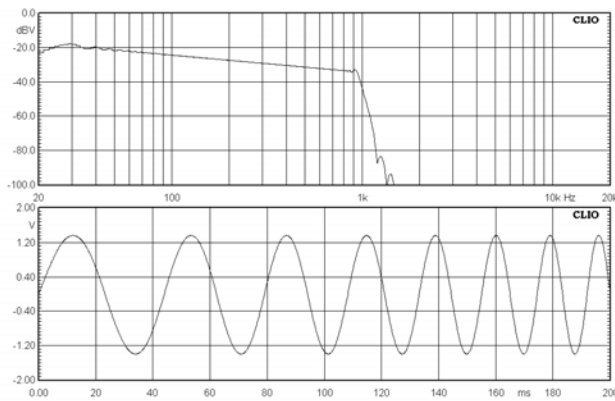

**Amplitude.** Perhaps this is the most critical parameter to set. Its choice must take into consideration T&S parameters of the device and tend to exploit the maximum excursion possible ( $X_{Max}$ ). On the other side a too high stimulus amplitude will tend to give false positives to R&B. The graph below shows excursion normalized versus  $Q_t$  and  $F_s$ ; it tells us that, in free air (as it is usually the case of production lines), maximum excursion is reached well below  $F_s$  (around  $0.1 * F_s$ ).

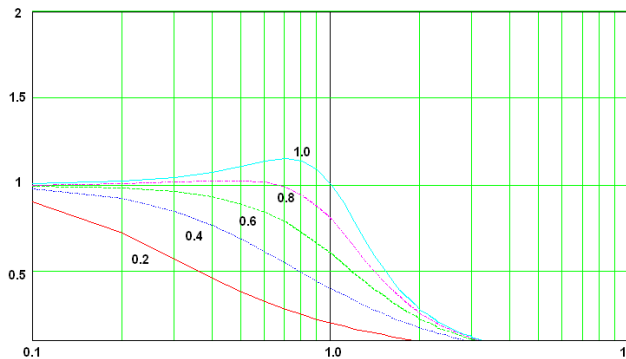

This leads us also to consider the technique described after (18.9.9) to apply DC and relax other parameters while augmenting R&B detection.

**Duration.** It is directly related to the chirp length; at 48 kHz sampling you get the following: a 16k chirp lasts around 0.35s, a 32k chirp lasts around 0.7s, a 64k chirp lasts around 1.4s and so on.

The choice should be consistent with your production test needs provided a longer test should be preferable as some kind of R&B phenomena appear with time as device thermal constants are reached. For the same reason if R&B is one among other QC tests, it should be done **at the end**.

Once the stimulus has been defined you must define a proper FFT QC test; be sure to use the same size of the stimulus, i.e. **FFT Size = Chirp Size**. Another important FFT parameter to set is smoothing which will present an easier to detect analysis; we suggest 1/48 or 1/24th of octave smoothing.

The analysis leads to the following situation:

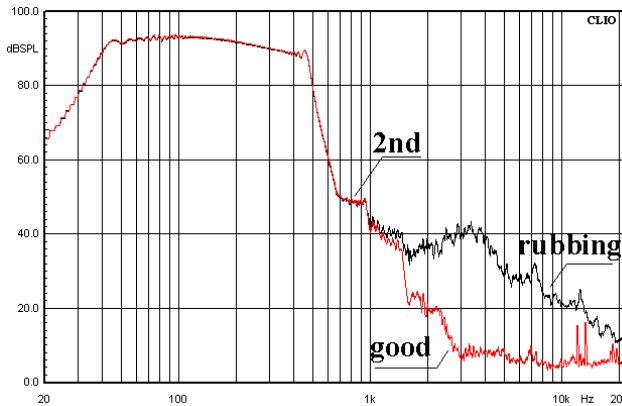

You can see the response of a good and a rubbing device which will lead you to correct mask definition; it is also shown how this measurement detects the harmonic signature of the device; the plateau marked with 2nd directly refers to second harmonic response.

This QC test is as simple as the following definition:

```
[FFT]
COMMENT=RUB&BUZZ
OUTQCBOX=2.83
IN=0
REFERENCE=RUB.FFT
LIMITS=RUB.LIM
```

We set 2.83V at the QCbox output (given a former OUTUNITS=V definition) and input at 0dBV. **Extreme care must be put in order to optimize input sensitivity** as this measurement is very sensitive to noise.

Limits mask should be placed in the decaying part of the acquisition and extended to cover the highest frequencies; only upper limit is necessary in this case.

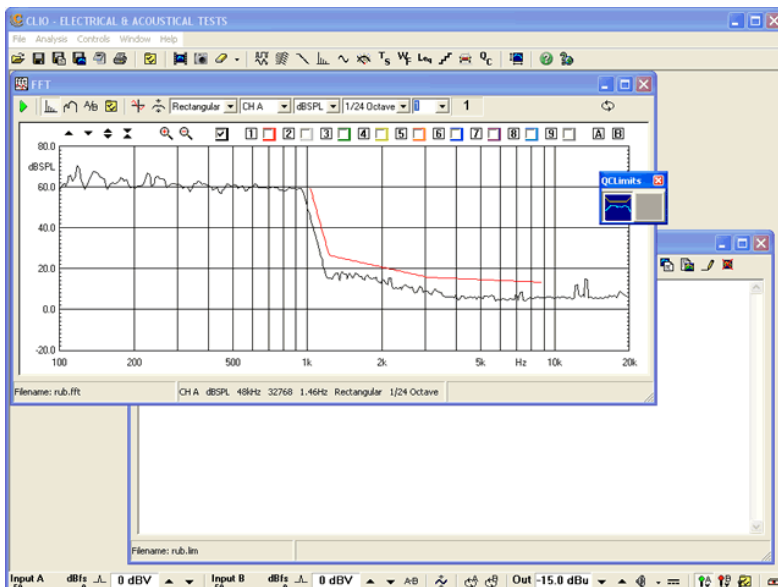

### 18.9.8 EXAMPLE 8: RUB & BUZZ DETECTION (2)

This example describes a second technique to detect rub&buzz in a production line of loudspeakers. The technique is based on a sinusoidal test with fifth harmonic detection which has proven to be sensitive to R&B.

The following figure shows the fifth harmonic sinusoidal response of a good and rubbing speaker:

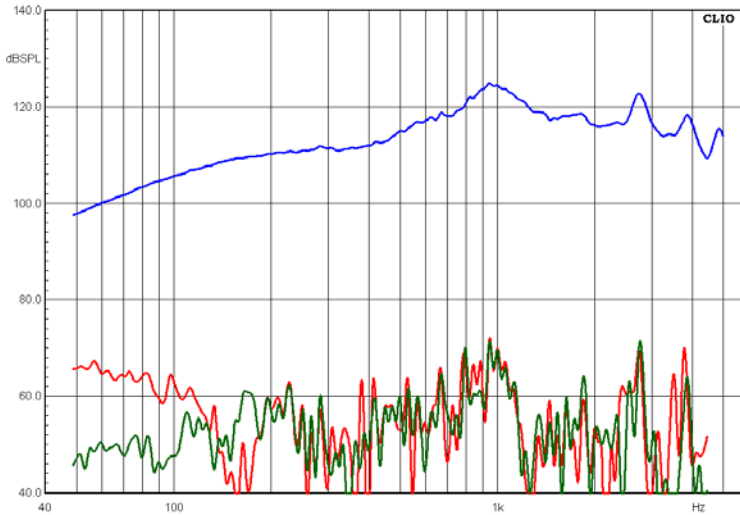

See 18.6.6 for setting up this kind of QC test. A QC test will be as simple as:

```
[SIN]
REFERENCE=RESPONSE.SIN
LIMITS=RESPONSE.LIM
```

Where the limit file will contain also a test mask for the fifth harmonic:

```
[UPPER LIMIT DATA]
.....
.....

[LOWER LIMIT DATA]
.....
.....

[5 UPPER LIMIT DATA]
.....
.....
```

### 18.9.9 EXAMPLE 9: RUB & BUZZ DETECTION (3)

This example describes a simple method to enhance rub&buzz detection. This method is based on the possibility of applying a DC voltage superimposed to the generated stimulus. This technique applies to any test possible with CLIO and augments its sensitivity.

As it is evident also from the figures in 18.9.7 the maximum excursion is obtained at DC and this is an effective way to bring the speaker to its limits. As it is evident from the following figure when a DC is applied the corresponding AC signal amplitude must be lowered to obtain similar excursion.

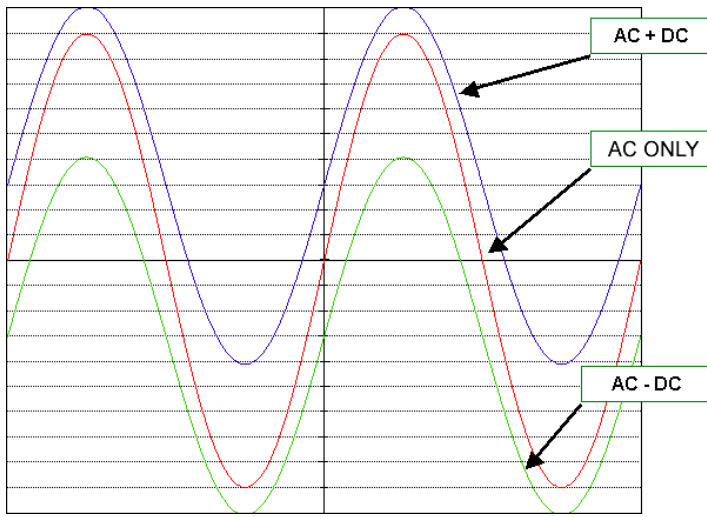

Applying a DC to the same QC test as described before in 18.9.8 it is possible to obtain the following measurement where it is evident the much better detection of the defect which is possible.

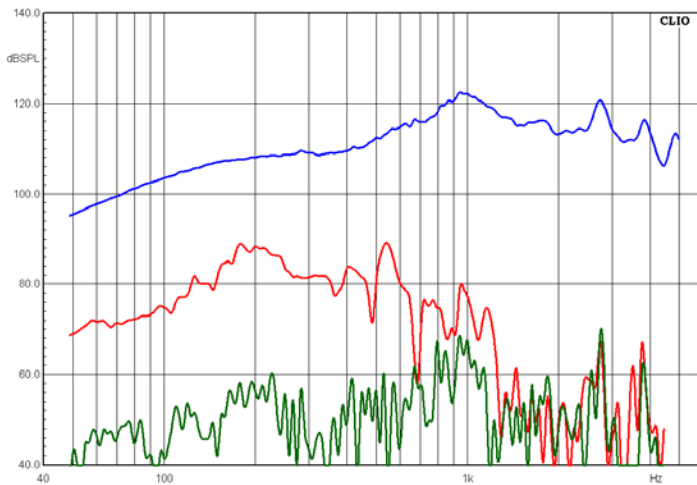

As described in 4.5.3 it is possible to manually set the DC voltage using the relative control panel.

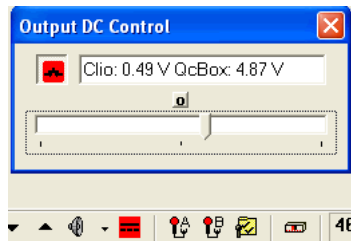

Under a QC script it is possible to apply DC with the following syntax:

```
[ PERFORM ]
DCON=1
[ SIN ]
DCVQCBOX=1.2
REFERENCE=RESPONSE.SIN
LIMITS=RESPONSE.LIM
```

```
[SIN]
DCVQCBOX=-1.2
REFERENCE=RESPONSE.SIN
LIMITS=RESPONSE.LIM
[PERFORM]
DCON=0
```

In this example it has been applied a 1.2V DC voltage to a sinusoidal test; the same could have been applied to a FFT with log chirp or any other test; **to be noted that the same test must be executed twice** as we don't know a priori which direction stimulates the defect to arise.

In this case also lower harmonics could be checked as, when DC is present, they become sensitive to R&B too.

## 18.10 QC SCRIPT SYNTAX REFERENCE

### 18.10.1 KEYWORDS FOR GENERAL SETTINGS

NOTE: "**SCRIPTDIR**" means the directory where the QC script is saved.

#### [GLOBALS]

Starts a section containing settings and definitions valid for the whole test sequence.

#### AUTOBATCH

=1 Enables automatic batch naming. The name of the production batch is set equal to the current name of the folder where the QC script is saved (SCRIPTDIR).

=0 Does not perform autobatch. If omitted defaults to 0.

AUTOSAVE =1 Autosaves all measurements. Applies to all measurements.

=0 Does not perform autosave. If omitted defaults to 0.

AUTOSN =1 Automatically manages and increments an 8-digits numerical serial number.

=0 Permits a 24 alphanumeric serial number to be fed to the QC processor; no automatic increment is performed.

If omitted defaults to 1 i.e. automatic serial numbering.

#### AUXMONITOR

=1 Activates the math operation monitor panel during QC execution.

=0 Does not activate the math operation monitor panel.

If omitted defaults to 0.

BATCH Name of the production batch. See also AUTOBATCH and SAVEFOLDER.

CYCLIC Name of the cyclic script. The cyclic script is executed every REPETITION times instead of the actual script. All measurements executed inside the cyclic script do not take part in production report, batch management and serial numbering. See also CYCLICFIRST.

#### CYCLICFIRST

=1 Executes the cyclic script before executing the QC test itself.

If omitted defaults to 0 i.e. no cyclic script executed first.

Refer also to CYCLIC and REPETITION for defining the cyclic script behavior.

COMPANY Text used as the first title of the QC control panel. Usually the company name.

DCON =1 sets DC voltage superimposed to channel A output active.

=0 sets DC voltage to 0.

If omitted defaults to 0.

DCV Value of output DC voltage to be set (see DCON).

#### DCVQCBOX

Value of output voltage to be set (see DCON) taking into account QCBox gain. This is the DC voltage that will be present at QCBox output..

DELAY Value in milliseconds of a pause to be performed.

**DISPLAY** =1 displays the result of each measurement.  
=0 executes all the measurements without displaying.  
If omitted defaults to 0 i.e. NOT DISPLAY.

**DISPLAYONBAD**  
=1 displays the measurement if bad. Applies to all the measurements.  
=0 Not active. If omitted defaults to 0.

**DISPLAYTIME**  
Approximate time of display (in ms) when in DISPLAY mode.

**IN** Sets the input sensitivity; if omitted autorange is activated.

**INA** Sets channel A input sensitivity; channel B sensitivity remains untouched.

**INB** Sets channel B input sensitivity; channel A sensitivity remains untouched.

**INITIALBITS**  
8-BIT binary value that will be output at startup before QC script execution.

**INCREASEONBAD**  
=1 Increases serial number when unit is bad.  
=0 Does not increase serial number when unit is bad.  
If omitted defaults to 1 i.e. increases on bad.

**INTERACTIVE**  
=1 displays the result of each measurement and prompts.  
=0 executes all the measurements without prompting.  
If omitted defaults to 0 i.e. NOT INTERACTIVE.

**MANUAL** =1 starts the QC sequence manually (pressing Go).  
=0 the sequence is started by an external trigger signal.  
If omitted defaults to 1 i.e. MANUAL.

**MESSAGEONBAD**  
Text to be displayed when unit performs bad.  
If omitted defaults to 'BAD'

**MESSAGEONGOOD**  
Text to be displayed when unit performs good.  
If omitted defaults to 'GOOD'

**OPENSERIAL**  
Opens the QC COM port for serial communication. See 6.3.6 for RS-232 settings. See also SERIALMONITOR.

**OUT** Sets the generator output level (with OUTUNITS defined under [GLOBALS]).

**OUTQCBOX**  
Sets the generator output level taking into account QCBox gain (with OUTUNITS defined under [GLOBALS]). This is the level that will be present at QCBox output.

**OUTUNITS** Sets the unit of measure of the output level. It is possible to set dBu, dBV or V.  
If omitted defaults to dBu.

PHANTOM =1 Switches phantom power supply on.  
=0 Switches phantom power supply off. If omitted defaults to 0.  
Valid through all the QC test sequence.

PROMPTFORGOOD  
=1 Prompts when unit is bad for user acceptance and overrides result.  
=0 No prompt when unit is bad.  
If omitted defaults to 0 i.e. no prompt.

RESETRESULTCOLOR  
=1 If multiple tests of the same kind are present resets the color of the display to match the last test of that kind.  
=0 If multiple tests of the same kind are present maintains the color of a bad result if any.  
If omitted defaults to 0 i.e. persistent color.

REPETITION  
Number representing the frequency of execution of the cyclic script.

SAVEBINARY  
=1 saves also in binary format if SAVETEXT=1. Ignored if used alone. Applies to all the measurements. If omitted defaults to 0. Remember that if neither SAVETEXT nor SAVEBINARY are specified the default format is binary.

SAVEFOLDER  
Forces the name of the autosave directory. If omitted the default autosave directory is SCRIPTDIR\AUTOSAVE if no batch name is defined, otherwise it is SCRIPTDIR\BATCH where BATCH is the name of production batch.  
If you desire to save files in the script directory itself use the particular syntax "SAVEFOLDER=" i.e. leave blank the right part.

SAVEONGOOD  
=1 Autosaves all measurements, if global result is good. Applies to all measurements.  
=0 Does not perform autosave. If omitted defaults to 0.  
If you want to autosave also in case of bad measurement add the keyword SAVEONBAD=1 under [GLOBALS].

SAVEONBAD  
=1 Autosaves all measurements, if global result is bad. Applies to all the measurements.  
=0 Not active. If omitted defaults to 0.  
Refer also to SAVEONGOOD and AUTOSAVE.

SAVETEXT =1 saves ASCII file instead of binary format. Applies to all the measurements.  
=0 saves files with normal binary format. If omitted defaults to 0.

SERIALMONITOR  
=1 Activates the RS-232 monitor panel during QC execution.  
=0 Does not activate the RS-232 monitor panel. If omitted defaults to 0.

STARTSIGLOGIC  
Defines the logic of the external trigger signal.  
=1 is active high.  
=0 is active low.  
If omitted defaults to 0 i.e. active low.

## STATISTICS

=1 Enables statistical data files generation.

=0 Disables statistical data files generation. If omitted defaults to 0.

## STATFILESRES

Number of data lines present in statistical frequency files; maximum is 2048.

**TITLE** Text used as the second title of the QC control panel. Usually a description of the test.

**WYSIWYG** =1 Enables wysiwyg processing.

=0 Disables wysiwyg processing. If omitted defaults to 0.

## 18.10.2 KEYWORDS FOR MEASUREMENTS SETTINGS

- [FFT] Starts a section containing the definition of an FFT measurement.
- [MLS] Starts a section containing the definition of an MLS measurement.
- [SIN] Starts a section containing the definition of a Sinusoidal measurement.
- [MET] Starts a section containing the definition of a Multimeter measurement.

### ACQUISITIONDELAY

Approximate time in milliseconds that is expected before executing the measurement after switching the generator on. Valid only for FFT and Multimeter measurements.

COMMENT Input a text comment used by the report files. This text is also output, during the script execution, in the measurement title bar.

DCON =1 sets DC voltage superimposed to channel A output active.  
=0 sets DC voltage to 0.  
If omitted defaults to 0.

DCV Value of output DC voltage to be set (see DCON).

### DCVQCBOX

Value of output voltage to be set (see DCON) taking into account QCBox gain. This is the DC voltage that will be present at QCBox output..

### DISPLAYONBAD

=1 displays the measurement if bad.  
=0 Not active. If omitted defaults to 0.

IN Sets the input sensitivity; if omitted autorange is activated.

INA Sets channel A input sensitivity; channel B sensitivity remains untouched.

INB Sets channel B input sensitivity; channel A sensitivity remains untouched.

LIMITS Name of the limits file.

LOOP =1 Loops the current Multimeter measurement to let the user perform an adjustment on the unit under test.  
=0 Executes the Multimeter measurement and exits.  
If omitted defaults to 0.

MODE =DIFFERENCE Executes the measurement referring it to the reference file.  
Valid only for MLS and Sinusoidal measurements.  
=NORMAL Executes the measurement normally.  
If omitted defaults to NORMAL

### OPERAND $n$ A

### OPERAND $n$ B

Define the operands of a mathematical operation (as described in 18.10.3).  $n$  denotes the relative operands number;  $n$  may range from 0 to 9.

Possible operands are:

LEVEL (MLS,sinusoidal,FFT)

SENSITIVITY	(MLS,sinusoidal,FFT)
FS	(T&S)
QTS	(T&S)
QES	(T&S)
QMS	(T&S)
VAS	(T&S)
BL	(T&S)
MMD	(T&S)
MMS	(T&S)
DBSPL	(T&S)
ZMIN	(T&S)
FREQUENCY	(multimeter)
IMD	(multimeter)
PRESSURE	(multimeter)
THD	(multimeter)
VOLTAGE	(multimeter)

OUT Sets the generator output level (with OUTUNITS defined under [GLOBALS]).

#### OUTQCBOX

Sets the generator output level taking into account QCBox gain (with OUTUNITS defined under [GLOBALS]). This is the level that will be present at QCBox output.

POLARITY =1 Executes a polarity check. Valid only for an MLS measurement.  
=0 Not Active. If omitted defaults to 0.

PROCESS Name of a process file to be applied to the test. Valid only for MLS and Sinusoidal measurements.

#### REFERENCE

Name of the reference file.

#### SAVEBINARY

=1 saves also in binary format if SAVETEXT=1. Ignored if used alone.  
If omitted defaults to 0. Remember that if neither SAVETEXT nor SAVEBINARY are specified the default format is binary.

SAVENAME Name of the file to be saved.

#### SAVEONBAD

=1 automatically saves the current measurement if bad.  
=0 Not active. If omitted defaults to 0.  
Refer also to AUTOSAVE.

#### SAVEONGOOD

=1 Autosaves the current measurements, if result is good.  
=0 Does not perform autosave. If omitted defaults to 0.  
If you want to autosave also in case of bad measurement add the keyword SAVEONBAD=1.

#### SAVEPROMPT

=1 Prompts the user for file name input.  
=0 Autosaves without prompting.  
If omitted defaults to 0.

SAVETEXT =1 saves ASCII file instead of binary format.  
=0 saves files with normal binary format. If omitted defaults to 0.

#### SAVETEXTPARAM

Controls the kind of exported data.

For MLS

=0 Display Frequency Data.

=1 FFT Frequency Data.

=2 Time Data.

For FFT

=0 Display Frequency Data.

=1 FFT Frequency Data.

=2 Last FFT Data.

=3 Last Time Data.

For Sinusoidal

=0 Frequency Data.

=1 Frequency Data + Harmonics.

#### SAVETEXTPARAM2

Controls the number of saved frequency points (valid only for MLS)

=0 saves 256 points.

=1 saves 512 points.

=2 saves 1024 points.

=3 saves 2048 points.

If omitted defaults to 0, i.e. 256 points.

### 18.10.3 KEYWORDS FOR MATH OPERATION

- [AUX]** Starts a section containing the definition of a math operation.
- TEST** Kind of math operation. To be chosen among the following:  
SUM $n$   
DIFFERENCE $n$   
MULTIPLICATION $n$   
DIVISION $n$   
where  $n$  denotes the relative operands number (see 18.10.2);  $n$  may range from 0 to 9.
- LOWER** Lower limit for the math operation check.
- UPPER** Upper limit for the math operation check.

## 18.10.4 KEYWORDS FOR CONDITIONAL EXECUTION

### [PERFORM]

Starts a section which is always executed, unaffected by the result of the preceding measurement. See below for the keywords possible within.

### [IF LAST GOOD]

### [IF LAST BAD]

Starts a section conditioned by the result of the preceding measurement.

### [IF *..parameter..* GOOD]

### [IF *..parameter..* BAD]

Starts a section conditioned by the result of one particular parameter measured during the preceding measurement.

*..parameter..* can be one of the following:

LEVEL	(MLS,sinusoidal,FFT)
SENSITIVITY	(MLS,sinusoidal,FFT)
RESPONSE	(MLS,sinusoidal,FFT)
POLARITY	(MLS)
2HARMONIC	(sinusoidal)
3HARMONIC	(sinusoidal)
4HARMONIC	(sinusoidal)
5HARMONIC	(sinusoidal)
TOTAL HARMONIC	(sinusoidal)
FS	(T&S)
QTS	(T&S)
QES	(T&S)
QMS	(T&S)
VAS	(T&S)
BL	(T&S)
MMD	(T&S)
MMS	(T&S)
DBSPL	(T&S)
ZMIN	(T&S)
FREQUENCY	(multimeter)
IMD	(multimeter)
PRESSURE	(multimeter)
THD	(multimeter)
VOLTAGE	(multimeter)

### [IF ALL GOOD]

### [IF ALL BAD]

Starts a section conditioned by the global result of the QC sequence.

Note: The following keywords apply to any kind of section for conditional execution.

**BIT**            Number of the bit to be singularly controlled with "BITVALUE".

**BITVALUE**

Status (=1 or =0) of the bit defined with "BIT".

**8BITVALUE**

8-BIT decimal value to be output by the currently selected parallel port..

- ABORT** Stops the script execution after executing all keywords in the current section. Result is forced bad. See also STOP.
- CLOSESERIAL**  
Closes the QC COM port after serial communication.
- DCON** =1 sets DC voltage superimposed to channel A output active.  
=0 sets DC voltage to 0.  
If omitted defaults to 0.
- DCV** Value of output DC voltage to be set (see DCON).
- DCVQCBOX**  
Value of output voltage to be set (see DCON) taking into account QCBox gain. This is the DC voltage that will be present at QCBox output..
- DELAY** Value in milliseconds of a pause to be performed.
- EXPORTGRAPHICS**  
Exports the current measurement to a graphical file. The same file naming convention used for data files is used.
- EXTERNAL** Name of an executable file to be launched. See also PARAMETERS and WAITCOMPLETION.
- IN** Sets the input sensitivity; if omitted autorange is activated.
- INA** Sets channel A input sensitivity; channel B sensitivity remains untouched.
- INB** Sets channel B input sensitivity; channel A sensitivity remains untouched.
- MESSAGE** Text to be displayed in a prompting message to the user.
- MESSAGE2** Second line of text to be displayed in a prompting message to the user.
- MESSAGE3** Third line of text to be displayed in a prompting message to the user.
- MESSAGE4** Fourth line of text to be displayed in a prompting message to the user.
- OPENSERIAL**  
Opens the QC COM port for serial communication. See 6.3.6 for RS-232 settings.
- OUT** Sets the generator output level (with OUTUNITS defined under [GLOBALS]).
- OUTQCBOX**  
Sets the generator output level taking into account QCBox gain (with OUTUNITS defined under [GLOBALS]). This is the level that will be present at QCBox output.
- PARAMETER1**  
String to be passed, as first parameter, to the executable defined with "EXTERNAL". Some parameters relative to the QC tests can be passed with the following acronyms:  
@SERIALNUMBER passes the current serial number.  
@RESULT passes the current result.

@LASTRESULT passes the last test result.  
@GLOBALRESULT passes the global test result.

#### PARAMETER2

String to be passed, as second parameter, to the executable defined with "EXTERNAL". See also PARAMETER1 above.

#### PARAMETER3

String to be passed, as third parameter, to the executable defined with "EXTERNAL". See also PARAMETER1 above.

#### PARAMETER4

String to be passed, as fourth parameter, to the executable defined with "EXTERNAL". See also PARAMETER1 above.

**PRINT** Prints the current measurement. The default Windows printer is used.

#### SERIALOUT

ASCII text to be sent to serial device.  
You may use some acronyms preceded by @:  
@SERIALNUMBER is translated in the current serial number  
@DATE is translated in the current date  
@TIME is translated in the current time

#### SERIALOUTFILE

Name of an ASCII file containing text to be sent to serial device.

**STOP** Stops the script execution after executing all keywords in the current section. Result is unaltered. See also ABORT.

#### WAITCOMPLETION

=1 The QC script wait for the external program to end before continuing execution.  
=0 The QC sequence continue without waiting. If omitted defaults to 0.

## 18.10.4 KEYWORDS FOR HARDWARE CONTROL

### [RESETLOOPA]

Opens internal loop on channel A. Valid only for CLIOwin running PB-4281 PCI card and SC-01 signal conditioner.

### [RESETLOOPB]

Opens internal loop on channel B. Valid only for CLIOwin running PB-4281 PCI card and SC-01 signal conditioner.

### [RESETMUTEA]

Switches mute for channel A off.

### [RESETMUTEB]

Switches mute for channel B off.

### [RESETPHANTOM]

Switches phantom power off.

### [SETIMPEDANCE]

Selects impedance mode of the CLIOQC Amplifier & SwitchBox.

### [SETINPUT1]

### [SETINPUT2]

### [SETINPUT3]

### [SETINPUT4]

### [SETINPUT5]

### [SETINPUT6]

### [SETINPUT7]

### [SETINPUT8]

Selects the relative input channel of the CLIOQC Amplifier & SwitchBox.

### [SETISENSE]

Selects isense mode of the CLIOQC Amplifier & SwitchBox.

### [SETLOOPA]

Closes internal loop on channel A. Valid only for CLIOwin running PB-4281 PCI card and SC-01 signal conditioner.

### [SETLOOPB]

Closes internal loop on channel B. Valid only for CLIOwin running PB-4281 PCI card and SC-01 signal conditioner.

### [SETMUTEA]

Switches mute for channel A on.

### [SETMUTEB]

Switches mute for channel B on.

### [SETPHANTOM]

Switches phantom power on.

## 18.10.5 OTHER KEYWORDS

### [SNINPUT]

Prompts the user for serial number input.

**[STOP]** Immediately stops the script execution.

## 18.10.6 KEYWORDS USED IN LIMITS FILES

### [ABSOLUTE]

Defines an absolute limit file. This is also the default condition when the [RELATIVE] keyword is not specified.

### [FLOATING]

If present forces floating limits curves.

### [RELATIVE]

Defines a relative limit file.

**[LEVEL]** Starts a section defining a check on the mean level of the measured curve.

### ALIGNFREQ

Align frequency for the mean level check. Valid only when ALIGNLEV is specified and it is not ALIGNLEV=REFERENCE. See below.

**ALIGNLEV** Align level for the mean level check. If it is specified as "ALIGNLEV=REFERENCE" then the mean level check is against the average level of the reference in the band defined by the frequency mask used for the response check. If omitted defaults to ALIGNLEV=REFERENCE.

**LOWER** Lower limit for the mean level check.

**UPPER** Upper limit for the mean level check.

**FREQLO** Lower frequency to calculate the mean level. If omitted the lower frequency is taken from the lowest frequency defined by the frequency mask.

**FREQHI** Upper frequency to calculate the mean level. If omitted the upper frequency is taken from the highest frequency defined by the frequency mask.

### [SENSITIVITY]

Starts a section defining a check on the sensitivity of the measured curve.

**LOWER** Lower limit for the sensitivity check.

**UPPER** Upper limit for the sensitivity check.

### FREQ1..FREQ8

Define up to eight frequencies where to calculate and then average sensitivity. If omitted the sensitivity is calculated from the frequency extremes defined by the frequency mask.

### [TSPARAMETERS]

Starts a section defining a Thiele&Small parameters check.

**REDC** Value (in Ohms) to be input representing the DC resistance of the voice coil. REDC must **always** be specified.

**DIAMETER** Input value (in mm) specifying the driver diameter. It is needed **only** when testing Cms, Mms, Mmd, Bl, Vas, dB SPL or ZMin; used with one of the fixed parameters: KNOWNMMD or KNOWNMMS or KNOWNCMS. **You must specify only one fixed parameter.**

**KNOWNMMD**

Input value for the fixed Mmd parameter. It is needed **only** when testing Cms, Mms, Mmd, BI, Vas, dBSPL or ZMin.

**KNOWNMMS**

Input value for the fixed Mms parameter. It is needed **only** when testing Cms, Mms, Mmd, BI, Vas, dBSPL or ZMin.

**KNOWNCMS**

Input value for the fixed Cms parameter. It is needed **only** when testing Cms, Mms, Mmd, BI, Vas, dBSPL or ZMin.

**FSLOWER** Lower limit for Fs.

**FSUPPER** Upper limit for Fs.

**QELOWER** Lower limit for Qes.

**QEUPPER** Upper limit for Qes.

**QMLOWER** Lower limit for Qms.

**QMUPPER** Upper limit for Qms.

**QTLOWER** Lower limit for Qts.

**QTUPPER** Upper limit for Qts.

**CMSLOWER**

Lower limit for Cms.

**CMSUPPER**

Upper limit for Cms.

**MMSLOWER**

Lower limit for Mms.

**MMSUPPER**

Upper limit for Mms.

**MMDLOWER**

Lower limit for Mmd.

**MMDUPPER**

Upper limit for Mmd.

**BLLOWER** Lower limit for BI.

**BLUPPER** Upper limit for BI.

**VASLOWER**

Lower limit for Vas.

**VASUPPER**

Upper limit for Vas.

**DBSPLLOWER**

Lower limit for dBSPL.

DBSPLUPPER

Upper limit for dBSPL.

ZMINLOWER

Lower limit for ZMin.

ZMINUPPER

Upper limit for ZMin.

**[UPPER LIMIT DATA]**

**[LOWER LIMIT DATA]**

Start a section containing the frequency mask used for the QC check. The frequency mask has to be defined as a list of N couples like:

**Frequency\_1      Value\_1**

.....

.....

**Frequency\_N      Value\_N**

In the case of a multimeter measurement containing several measured parameters value.

It is possible to load frequency data from an external ASCII text file using the FILE keyword.

FILE      Name of a text file containing a frequency mask definition.

FREQUENCY

Executes a frequency check. Valid for a multimeter measurement.

IMD

Executes an intermodulation distortion check. Valid for a multimeter measurement.

PRESSURE

Executes a sound pressure level check. Valid for a multimeter measurement.

THD

Executes a total harmonic distortion check. Valid for a multimeter measurement.

VOLTAGE

Executes a voltage check. Valid for a multimeter measurement.

**[2 UPPER LIMIT DATA]**

**[2 LOWER LIMIT DATA]**

**[3 UPPER LIMIT DATA]**

**[3 LOWER LIMIT DATA]**

**[4 UPPER LIMIT DATA]**

**[4 LOWER LIMIT DATA]**

**[5 UPPER LIMIT DATA]**

**[5 LOWER LIMIT DATA]**

### [THD UPPER LIMIT DATA]

### [THD LOWER LIMIT DATA]

Start a section containing the frequency mask used for the QC check of the THD or single harmonics of a sinusoidal frequency sweep.  
The presence of the relative section defines the QC check.  
The frequency mask has to be defined as a list of N couples like:

**Frequency\_1      Value\_1**  
.....  
.....  
**Frequency\_N      Value\_N**

It is possible to load frequency data from an external ASCII text file using the FILE keyword.

FILE      Name of a text file containing a frequency mask definition.

### [REFERENCE DATA]

Start a section containing the frequency response used as reference; if present substitute data taken from the reference file (as defined in 18.3).  
The frequency mask has to be defined as a list of N couples like:

**Frequency\_1      Value\_1**  
.....  
.....  
**Frequency\_N      Value\_N**

It is possible to load frequency data from an external ASCII text file using the FILE keyword.

FILE      Name of a text file containing a frequency mask definition.



# BIBLIOGRAPHY

- [1] Joseph D'Appolito, "Testing Loudspeakers", Audio Amateur Press, 1998.
- [2] J.M. Berman and L.R. Fincham, "The Application of Digital Techniques to the Measurement of Loudspeakers", J. Audio Eng. Soc., Vol. 25, 1977 June.
- [3] L.R. Fincham, "Refinements in the Impulse Testing of Loudspeakers", J. Audio Eng. Soc., Vol. 33, 1985 March.
- [4] S.P. Lipshitz, T.C. Scott and J. Vanderkooy, "Increasing the Audio Measurement Capability of FFT Analyzers by Microcomputer Postprocessing", J. Audio Eng. Soc., Vol. 33, 1985 September.
- [5] D.D. Rife and J. Vanderkooy, "Transfer Function Measurement with Maximum-Length Sequences", J. Audio Eng. Soc., Vol. 37, 1989 June.
- [6] A. Duncan, "The Analytic Impulse", J. Audio Eng. Soc., Vol. 36, 1988 May.
- [7] J. Vanderkooy and S.P. Lipshitz, "Uses and Abuses of the Energy-Time Curve", J. Audio Eng. Soc., Vol. 38, 1990 November.
- [8] G. Ballou, "Handbook for Sound Engineers – The New Audio Cyclopedia", Howard W. Sams & Company, 1987.
- [9] D. Davis and C. Davis, "Sound System Engineering", Howard W. Sams & Company, 1987.
- [10] R.H. Small, "Simplified Loudspeaker Measurements at Low Frequencies", J. Audio Eng. Soc., 1972 Jan/Feb.
- [11] D.B. Keele Jr, "Low Frequency Loudspeaker Assessment by Near-field Sound Pressure Measurements", J. Audio Eng. Soc., 1974 April.
- [12] W.D.T. Davies, "Generation and properties of maximum length sequences", Control, 1966 June/July/August.
- [13] F.J. MacWilliams and N.J.A. Sloane, "Pseudo-random sequences and arrays", Proc. IEEE, 1976 December.
- [14] M.R. Schroeder, "Integrated impulse method measuring sound decay without using impulses", J. Acoust. Soc. Am., 1979 August.
- [15] J. Borish and J.B. Angell, "An efficient algorithm for measuring the impulse response using pseudorandom noise", J. Audio Eng. Soc., 1983 July/August.
- [16] D.D. Rife, "Maximum length sequences optimize PC-based linear system analysis", Pers. Eng. Inst. News, 1987 May.
- [17] C. Dunn and M.O. Hawksford, "Distortion Immunity of MLS-Derived Impulse Response Measurements", J. Audio Eng. Soc., 1993 May.
- [18] R.H. Small, "Direct-Radiator Loudspeaker System Analysis", J. Audio Eng. Soc., 1972 June.
- [19] M.O. Hawksford, "Digital Signal Processing Tools for Loudspeaker Evaluation and Discrete-Time Crossover Design", J. Audio Eng. Soc., 1997 January/February.

- [20] D. Clarke, "Precision Measurement of Loudspeaker Parameters", J. Audio Eng. Soc., 1997 March.
- [21] IASCA - International Auto Sound Challenge Association Inc. - "Official Judging Rules".
- [22] A.Farina, "Simultaneous measurements of impulse response and distortion with a swept sine technique", AES Preprint n.5093, 108th Convention, 2000 February.
- [23] S.Mueller and P.Massarini, "Transfer function measurement with sweeps", J. Audio Eng. Soc., 2001 June.
- [24] T.Kite, "Measurements of audio equipment with log-swept sine chirps", AES Preprint n.6269, 117th Convention, 2004 October.

# NORMS

- [1] IEC 61672, Sound Level Meters (replacing former IEC 651, Sound level meters and IEC 804, Integrating-averaging sound level meters).
- [2] IEC 60268, Sound system equipment.
- [3] IEC 60386, Methods of measurement of speed fluctuations in sound recording and reproducing equipment.
- [4] ISO 226, Normal equal-loudness-level contours.
- [5] ISO 266, Preferred frequencies for measurements.
- [6] ISO 3382, Measurement of reverberation time of rooms with reference to other acoustical parameters.
- [7] IEC 61260, Octave-band and fractional-octave-band filters.
- [8] SMPTE RP120, Measurement of Intermodulation Distortion in Motion-Picture Audio Systems.

